



ZETA  TM

Model SKT-2300

Helical Scan Tape Subsystem

Technical Manual

Document No: 600-480-00
Revision: B
Date: 8/21/89

NOTICE

Zetaco, Inc. has prepared this Technical Manual for use by Zetaco personnel and its customers to assist in the installation, operation and maintenance of the SKT-2300 Helical Scan Tape Subsystem. The information contained herein is the property of Zetaco and shall not be reproduced in whole nor in part without prior written approval of Zetaco.

Zetaco makes every effort to produce quality products and documentation, however, the reader must be cautioned that changes may be made to the product not reflected in the supplied documentation. If you find errors or omissions, please notify Zetaco to remedy the problem. You may mail in the form on the last page of this manual, postage paid, with your comments. Zetaco shall not be responsible for any damages (including consequential) caused by reliance on this material as presented.

Copyright 1989, Zetaco, Incorporated. All rights reserved.
Zetaco is a subsidiary of Carlisle Corporation.

MVSYSTEMX, CONTEST, MLTT RELI, MTJ, MTA, MTC, MTD and *sysadm* are trade names of Data General Corporation.

Exabyte is a trade name of Exabyte Corporation.

CONFIDENTIAL - 1950
SECRET

CONFIDENTIAL - 1950
SECRET

CONFIDENTIAL - 1950
SECRET

CONFIDENTIAL - 1950
SECRET

CONFIDENTIAL - 1950
SECRET

CONFIDENTIAL - 1950
SECRET

CONFIDENTIAL - 1950
SECRET

Warning

This equipment generates, uses, and can radiate radio frequency energy and if not installed and used in accordance with the instructions manual, may cause interference to radio communications. It has been tested and found to comply with the limits for a Class A computing device pursuant to Subpart J of Part 15 of FCC Rules, which are designed to provide reasonable protection against such interference when operated in a commercial environment. Operation of this equipment in a residential area is likely to cause interference in which case the user at his own expense will be required to take whatever measures may be required to correct the interference.

Warning

This digital apparatus does not exceed the CLASS A limits for radio noise for digital apparatus set out in the Radio Interference Regulations of the Canadian Department of Communications.

Technical Manual for the SKT-2300 Helical Scan Tape Subsystem

Preface

This manual contains information regarding installation, testing, and operation of the Zetaco SKT-2300 Helical Scan Tape Subsystem. It has been written with the following assumptions in mind:

- 1) *You have a working knowledge of Data General (DG) Minicomputers, operating systems, and diagnostic and utility software;*
- 2) *you have access to full hardware and software documentation for your particular system;*
- 3) *you are familiar with standard installation, power, grounding, and peripheral cabling procedures.*

The information in this manual is organized into four major sections:

- | | |
|--------------------|--|
| SECTION 1.0 | <i><u>Product Overview</u> - SKT-2300 Subsystem features, capabilities, specifications, power, and interface requirements.</i> |
| SECTION 2.0 | <i><u>Installation Procedures</u> - Procedures required to install and test the SKT-2300 Subsystem.</i> |
| SECTION 3.0 | <i><u>Troubleshooting</u> - How to analyze subsystem problems; how to get help.</i> |
| SECTION 4.0 | <i><u>Usage Guidelines</u> - Back-up utilities and programs; and how to care for SKT-2300 tapes and drive.</i> |

21

1970

1971

1972

1973

1974

1975

1976

1977

1978

1979

1980

1981

1982

1983

1984

1985

1986

1987

1988

1989

1990

1991

1992

1993

1994

1995

1996

1997

1998

1999

Table of Contents

Section

1.0	Product Overview	1-1
	<i>General Description</i>	1-1
	<i>Features</i>	1-1
1.1	SCZ-4 Controller Specifications	1-2
	<i>Computer Interface</i>	1-2
	<i>BMC Bus Cables</i>	1-3
	<i>Tape Drive Interface</i>	1-3
	<i>Mechanical</i>	1-3
	<i>Power Requirements</i>	1-3
	<i>Environmental</i>	1-3
1.2	Tape Drive Specifications	1-4
	<i>Mechanical</i>	1-4
	<i>Power Requirements</i>	1-4
	<i>Environmental</i>	1-4
	<i>Regulatory & Safety Agency Standards</i>	1-5
1.3	Cabling	1-6
	<i>Internal Cabling</i>	1-6
	<i>External Cabling</i>	1-6

2.0	Before You Begin Installation	2-1
	<i>Overview of the Installation Process</i>	2-1
2.1	Hardware Installation as a Process	2-2
	<i>What to do if there is Damage</i>	2-3
2.1.1	Selecting a Slot & Making it Functional	2-4
	<i>Slot Selected Must be I/O ONLY</i>	2-4
	<i>Availability to BMC</i>	2-5
	<i>Priority Must be Maintained</i>	2-5
	<i>Pin-to-Pin Connections</i>	2-5
2.1.2	Jumpers & Switches	2-6
	<i>Choosing the Device Code Address</i>	2-6
	<i>When to Use the E²PROM Write Disable</i>	2-6
	<i>Using Configuration Over-ride</i>	2-6
2.1.3	Installing Controller & Paddleboard	2-8
	<i>How to Properly Install the Controller into its Slot</i>	2-8
	<i>How to Properly Install the SKT-2300 Paddleboard</i>	2-8
2.1.4	Setting up the Cartridge Tape Drive	2-10
	<i>How to Access the Unit Select Switches</i>	2-10
	<i>Setting the Switches</i>	2-10
	<i>Apply Power to the Tape Drive</i>	2-10
2.1.5	How to Load/Unload Write-Enabled Tape	2-12
	<i>The Write Protect Tab</i>	2-12
	<i>Cartridge Tape LOAD & UNLOAD Procedures</i>	2-12
2.1.6	Using More Than One Cartridge Tape Drive	2-14
	<i>How Many Drives can be Added?</i>	2-14
	<i>Terminate the Bus</i>	2-15

2.1.7	Where to Use the Cables You Received	2-16
	<i>Connecting Internal & External Drive Cables</i>	2-16
	<i>Providing Access to the BMC Bus for the</i>	
	SCZ-4 Controller	2-16
	<i>Providing Termination for the BMC Bus</i>	2-17
2.2	How to Check for Normal Power-Up	2-18
2.3	The Software Installation Process	2-20
	<i>Have Enough Reference Material Ready</i>	2-20
	<i>System Requirements for Installation</i>	2-21
2.3.1	Using the Support Package Tape	2-22
	<i>What the Files on the Tape are For</i>	2-22
	<i>How to Access the Tape</i>	2-22
2.3.2	Using the Configurator Program to Set Options	2-24
2.3.3	More Information on Which Options to Change	2-26
	<i>BMC Options</i>	2-26
	<i>Selecting SCSI ID for the SCZ-4</i>	2-27
2.3.4	Using the Reliability Program	2-28
	<i>Choosing the Program Global Parameters</i>	2-28
	<i>The Program Sequence to Follow</i>	2-29
2.3.5	Summary of Reliability Commands	2-30
	<i>The Main Menu Options</i>	2-30
2.3.6	Preparation Under the Operating System	2-32
	<i>Why Run VSGEN or sysadm?</i>	2-32
	<i>What to Know Before You Run VSGEN or</i>	
	<i>sysadm Programs</i>	2-32
	<i>Loading Support Tape Files Onto an</i>	
	AOS/VS System Disk	2-33
	<i>Standard CLI Commands to Load File 4</i>	2-33

3.0	Troubleshooting: How to Diagnose What is Wrong . . .	3-1
	<i>Power-up Problems</i>	3-1
	<i>Test Programs to Use</i>	3-1
	<i>Other Support</i>	3-1
3.1	Interpreting Tape Drive Faults at Power-Up	3-2
	<i>Normal Power-Up Initialization</i>	3-2
	<i>Self-test That Does Not Complete</i>	3-2
3.2	Interpreting Controller Self-test Errors at Power-Up . . .	3-4
3.2.1	Identifying the Self-test Failure	3-6
	<i>Host Side Error Decoding</i>	3-6
	<i>SCSI Side Error Decoding</i>	3-6
3.2.2	Decoding LED Flashed Errors Other than During Self-test	3-8
	<i>Meaning of a Steadily Lit Yellow LED</i>	3-9
3.3	Problems Running the Utility Programs	3-10
	<i>Assumptions About the Installation</i>	3-10
	<i>Two Common Difficulties When Running the Programs</i> .	3-10
3.4	Types of Error Messages From Reliability	3-12
	<i>Description of PIO and CB Error Reporting</i>	3-12
	<i>Tape Hard Error Messages</i>	3-13
	<i>Data Compare Errors Can also Occur</i>	2-14
3.5	Error Messages From the System	3-16
	<i>Recovering From a PANIC</i>	3-16
	<i>Using MVSYSYSTEMX</i>	3-16
	<i>Using CONTEST</i>	3-17
	<i>System Error Without PANIC Crash</i>	3-17

3.5.1	Interpreting CB and PIO Status	3-18
	<i>The Difference Between CB Status & PIO</i>	3-18
	<i>CB Status Meaning</i>	3-18
	<i>PIO Status Meaning</i>	3-20
3.6	Help is Available for Problem Situations	3-22
	<i>Who to Call First</i>	3-22
	<i>You Can Use the Customer Support Hotline</i>	3-22
	<i>How to Get a Return Material Authorization (RMA)</i>	3-22
3.6.1	Information You May Need About Your Warranty	3-23
4.0	Using the SKT-2300 Efficiently	4-1
4.1	Setting up a Back-up Program	4-2
	<i>A Word About Block Size</i>	4-2
	<i>Writing a Back-up Macro</i>	4-2
4.2	Commands MTJ Understands	4-4
	<i>Tape Commands in AOS/VS</i>	4-4
	<i>Creating a Physical Copy of Your Disk in AOS/VS</i>	4-5
	<i>Tape Commands With DG/UX</i>	4-5
4.3	Caring for Tapes & Tape Drive	4-6
	<i>Which Tapes to Use</i>	4-6
	<i>Advice on Storing Tapes</i>	4-6
	<i>Advice on Handling & Using Tapes</i>	4-6
	<i>Advice on Cleaning the Tape Drive</i>	4-7

List of Tables

Table 2.1.1	Identification of I/O ONLY Slots	2-4
Table 2.1.4	SCSI ID Switches	2-11
Table 2.2	Hardware Installation Checklist	2-19
Table 3.1	Definition of Tape Drive LEDs	3-3
Table 3.2	What the LEDs Mean	3-5
Table 3.2.3	Common Problems & Solutions Using Utility Programs	3-11
Table 3.5.1a	Meaning of CB Status Word	3-18
Table 3.5.1b	Meaning of Error & Unit Status Words from a CB	3-19
Table 3.5.1c	Meaning of CB Unit Status	3-19
Table 3.5.1d	Meaning of PIO Register C	3-20
Table 3.5.1e	Meaning of PIO Register B	3-21

List of Figures

Figure 2.1.1	Backplane Priority Jumpers	2-5
Figure 2.1.2	Device Code Switches Located on Controller	2-7
Figure 2.1.3	Installing the Paddleboard and Controller	2-9
Figure 2.1.4	Tape Drive Front Panel	2-11
Figure 2.1.5	Location of Write Protect Tab	2-13
Figure 2.1.6	Daisy-Chained Tape Drives	2-15
Figure 2.1.7	SCZ-4 Cabling Diagram	2-17
Figure 2.3.1	Menu of the Support Tape	2-23
Figure 2.3.2a	Configuration Overview Screen	2-25
Figure 2.3.2b	Configurator Main Menu	2-25
Figure 2.3.4	Main Menu of Reliability Test Program	2-28
Figure 3.2	LED Status Indicators	3-5
Figure 3.2.1	Getting an Octal Number from LEDs	3-7
Figure 3.4a	CB Type Error Reports	3-12
Figure 3.4b	PIO Type Error Reports	3-13
Figure 3.4c	Data Compare Error Reports	3-14

List of Examples

Example 4.1a Partial AOS/VS Back_up_file	4-3
Example 4.1b Partial DG/UX Backup File	4-3

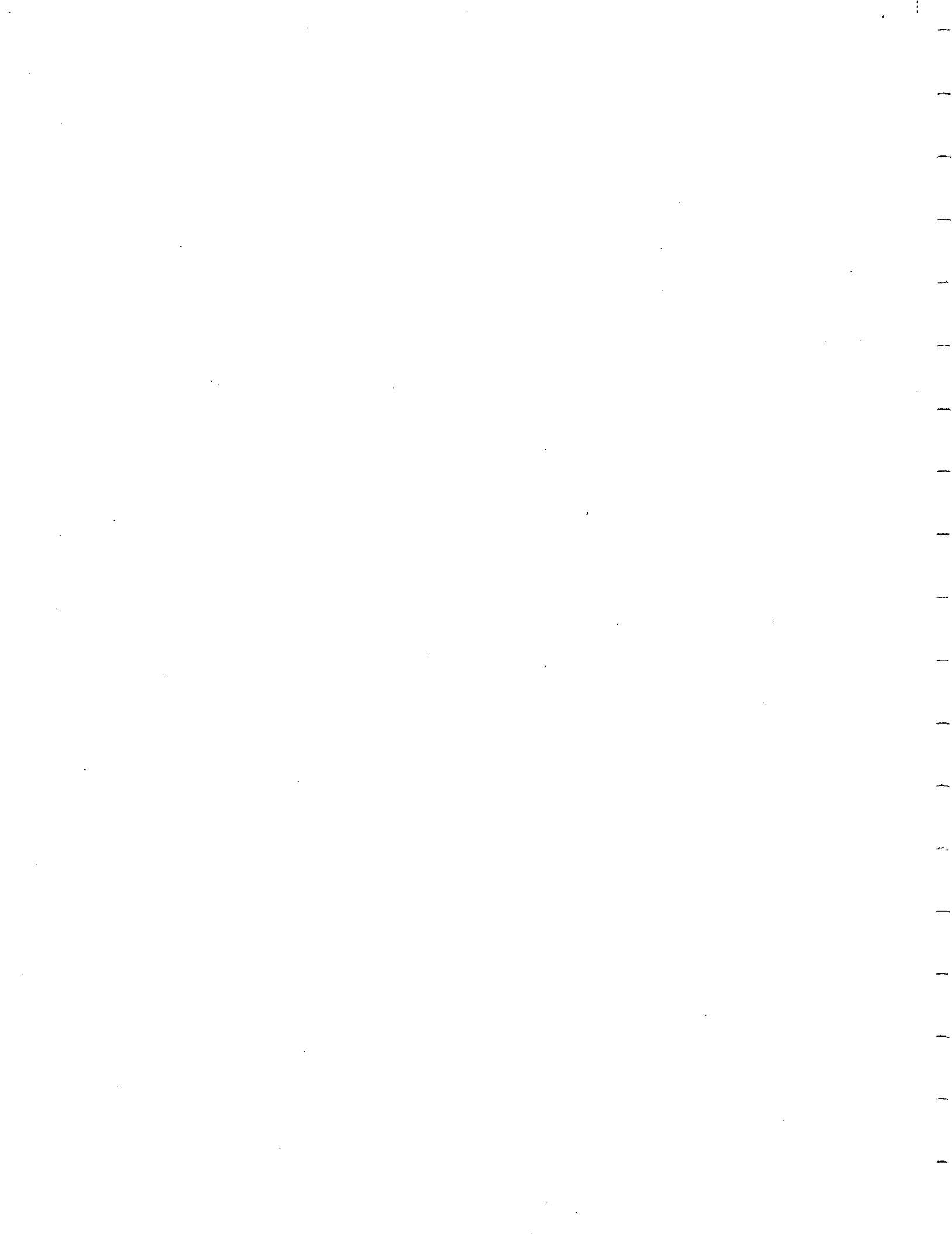

1.0 Product Overview

General Description

The SKT-2300 subsystem combines Zetaco's SCZ-4 Tape Controller with an Exabyte tape drive Model 8200. Up to 2 gigabytes of data fit on one tape, or smaller capacity tapes can be used. The result is a convenient and workable tape cartridge back-up system.

At the system level, the SKT-2300 utilizes the Data General MTJ driver capabilities. It is compatible with all tape commands supported by MTJ.

All parts of an SKT-2300 subsystem are integrated at Zetaco to make a complete unit. The components have been designed and tested together to provide a quality subsystem on which you can rely.

Features

- Adherence to Common Command Set SCSI Protocol insures drive compatibility
- Command queueing
- Large on-board memory
- Dual microprocessors with full parallel processing
- Automatic self-test and error/status LED display
- High capacity tapes for easier back-up of large disk drives

1.1 SCZ-4 Controller Specifications

Drives per Coupler: Up to 7 SCSI targets (limited to 4 by AOS/VS or 2 for DG/UX)

Data Transfer Rate: Up to 5 MB/sec (Synchronous)
Up to 3 MB/sec (Asynchronous)

Device Code: Switch Selectable

Interrupt Priority Mask Bit: Bit 10

Bus Load: 1 unit load (any I/O ONLY slot)

Data Channel Interface: Not Supported

Burst Multiplexor Channel Interface:

- Less than 1 STTL load
- 64ma drive at 0.7v
- Supports selectability of any of the 8 priority requests
- Selectable burst rates of 1 to 256, 16 bit words/access
- Selectable break count from 1 to 255 sync clock periods
- Support BMC transfer rates equal to the fastest available BMC computers

Data Buffering: Two 256-word BMC buffers in a ping-pong configuration. Also, buffering provided on the drives.

Memory Address: 21 bits

LED Indicators:	RED	(Right)	Self-test (HOST)
	RED	(Left)	Self-test (SCSI)
	GREEN	(Right)	Controller Busy (HOST)
	GREEN	(Left)	SCSI Busy
	YELLOW	(Right)	BMC Active
	YELLOW	(Left)	SCSI bus fault

Computer Interface

The SCZ-4 is designed to operate only with the BMC and must be installed in an I/O ONLY slot of an MV computer. Its operating system must support the MTJ driver. Table 2.1.1 lists the Data General computers in which the SCZ-4 will function, along with corresponding I/O ONLY slot numbers.

BMC Bus Cables

To operate the SCZ-4 over the BMC channel, a physical connection between the SCZ-4 and the Data General BMC channel is required. This connection is made via two 40-conductor flat ribbon cables. Each has a single socket on one end (for the BMC controller) and multiple sockets (for multiple boards accessing the BMC) on the other.

Tape Drive Interface

The SCZ-4 communicates to the cartridge tape drive via the SCSI interface. It can operate in synchronous or asynchronous mode. The SCZ-4 is fully operational with either differential or single-ended drives. The standard SKT-2300 Subsystem is differential. (Different paddleboards and cables are required for each type. They should never be mixed.)

Mechanical

Dimensions: 15" x 15" (37cm x 37cm)

Shipping Weight: 10 pounds (4.536 kg) (includes controller, paddleboard, internal cable, software tape and documentation)

Paddleboard: Active component design with one 50-pin cable connector (A-side of backplane)

Power Requirements

+5 vDC ($\pm 5\%$) at 8 amps typical

Environmental

Operating Environment:

Temperature: 0 to 55°C

Relative Humidity: 10% to 90% (non-condensing)

Non-Operating Environment:

Temperature: -45 to +115°C

Relative Humidity: 10% to 90% (non-condensing)

Exceeds all MV temperature and humidity specifications.

1.2 Tape Drive Specifications

Recording Format: Helical Scan

Cartridge: 8mm Industry Standard

Cartridge Sizes: 256 - 2300 MB

Error Checking: Read after Write; Auto re-write

Non-Recoverable Error Rate: less than one bit in 10^{13} bits read

Buffer: 256 KB

Effective Head-to-Tape Speed: 150 inches/sec

SCSI Bus Data Transfer Rates: Up to 1.5 MB/sec

Mechanical

Dimensions of drive in enclosure:

Height: 5 inches (12.7 cm) (including feet)

Width: 9 inches (22.86 cm)

Depth: 12 inches (30.48 cm)

Shipping Weight: 15 pounds (33 kg)

Power Requirements

AC Input: 95-264 vAC

Frequency: 47-63 Hz

Maximum AC Operating Current: 4 amps

Fuse: 1 amp @ 250 vAC

Environmental

Operating Environment:

Temperature: +5 to +40°C

Relative Humidity: 20% to 80% (non-condensing)

Altitude: -984.3 to +9843 feet

Non-Operating Environment:

Temperature: -45 to +115°C

Relative Humidity: 10% to 90% (non-condensing)

Altitude: -984.3 to +40,026 feet

**Regulatory &
Safety
Agency
Standards**

The SKT-2300 tape drive is certified to the following standards:

REGULATORY AGENCY:

- FCC Rules, Part 15, Subpart J, Class B, Computing Devices
- VDE 0871, Class B

SAFETY AGENCY:

- UL 478, 5th Edition, Standard for Safety, Information Processing and Business Equipment
- CSA Standard C22.2 No. 220. Data Processing Equipment Safety
- IEC 950, Safety of Electrically Energized Office Machines (as tested by TUV and displaying the TUV GS mark)

1.3 Cabling

Internal Cabling

Paddleboard: Active backplane paddleboard with one 50-pin connector

Cable: 28" standard 50-conductor flat ribbon cable

External Cabling

Bulkhead-to-Drive: Nine foot, 50-conductor, shielded round cable connecting backpanel to drive enclosure

Drive-to-Drive: Two foot, 50-conductor, shielded round cable (optional) for connecting more drives

Non-bulkhead installation kit available.

NOTE The maximum cumulative cable length allowable for a fully populated subsystem is 82 feet for differential drives.

Contact Zetaco for cable lengths different from the standard shipped.

2.0 Before You Begin Installation

The installation process can readily be divided into two parts: hardware and software. Hardware installation is covered first in the following sections. Every attempt has been made to cover the process sequentially. It would be a good idea to read through all the information before doing anything and to have on hand the tools and references suggested.

Overview of the Installation Process

The Installation Process described in the following sections is designed to proceed step by step and provide methods for you to verify results. After you have all hardware in place, the checklist and power-up sequence provides a partial confirmation of success.

In the software section, using the Support Package Tape programs and other optional system tests, you can further determine your success.

Diagram of Installation Process

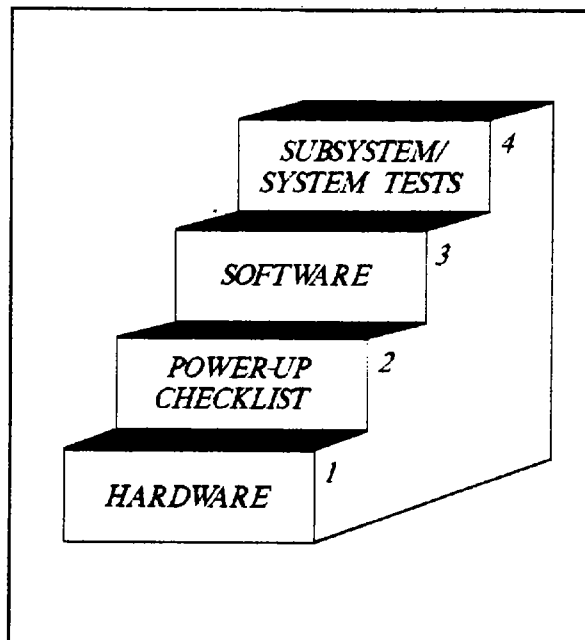

2.1 Hardware Installation as a Process

The hardware covered in this section includes the computer chassis, the SCZ-4 Tape Controller, the cartridge tape drive, and the cables. Any changes you may need to make to the hardware are described in the appropriate section.

Installation Steps

Each of the following sections details one of these steps for installation of the SKT-2300:

1. Selecting a slot for the SCZ-4 in the computer chassis and making it functional.
2. What to do with the jumpers and switches on the SCZ-4 controller.
3. Installing the SCZ-4 and paddleboard into the chassis.
4. Setting up the cartridge tape drive.
5. Connecting all cables; Drive and BMC.

Since so much of the installation depends on complying with Data General architecture, it would be valuable to have reference material about the system hardware on hand. For example, in order to access the backplane to install the SKT-2300 paddleboard, it will be necessary to remove the backpanel bulkhead (if FCC compliant). It may not be clear how to do this by just looking at it.

There are a variety of ways Data General sets up its computers.

- Some have vertically mounted boards, some are horizontal.
- Some have one IOC, others have more.
- Bus repeaters may be installed or an expansion chassis.

Tools You May Need

The scope of these installation instructions is broad. You must have enough information about the system itself to fill in the details. **Tools you may need for installation:**

1. A Phillips screwdriver
2. A set of nut drivers
3. A small straight-blade screwdriver
4. A large straight-blade screwdriver
5. A set of needlenose pliers
6. A flashlight
7. A #T15 Torx screwdriver (optional)

The SCZ-4 is a sensitive piece of electronic equipment. Observe precautions to prevent damage by static; wear a wrist band and strap while handling the controller.



***What to do if
there is
damage...***

Immediately after receiving it and before you unpack your ZETACO shipment, inspect the shipping carton(s) for any evidence of damage or mishandling in transit.

Zetaco's warranty does not cover shipping damages. Therefore, if the shipping cartons are water stained or otherwise damaged, contact the carrier or shipping agent, before opening, with information on the damage. Request that a representative be present during receiving inspection.

For repair or replacement of any Zetaco product damaged in shipment, call Zetaco for return instructions and authorization.

2.1.1 *Selecting a Slot & Making it Functional*

The first thing to do is determine which slot of the computer can be used for the SCZ-4. Then, be sure the priority signals are available for that slot.

Slot Selected Must be I/O ONLY

The SCZ-4 must be installed in an I/O ONLY slot. Each type of Data General computer reserves different slots as I/O ONLY. Refer to Table 2.1.1 for this specific information. Examine the computer to determine which of the proper slots are free. It may be necessary to rearrange boards to accommodate the SCZ-4 in an I/O ONLY slot.

CAUTION:

Component damage will result and Zetaco's warranty is VOID if anything other than an I/O ONLY slot is used.

Table 2.1.1 Identification of I/O ONLY Slots

CPU Model I/O ONLY Slot Numbers

MV/4000	12 - 20
MV/6000	2 - 16 (I/O Expansion Chassis)
MV/7800	Chassis dependent (See Note, below)
MV/8000	29, 42, 48 - 56
MV/8000II	9 - 21
MV/8000C	13 - 20
MV/10000	13 - 24, 26 - 36
MV/20000	19 - 38
MV/40000	Any Eclipse I/O Slot

NOTE

Since the MV/7800 is an upgrade vehicle for Data General machines, it can be installed in a variety of chassis types. Choose a slot defined as I/O ONLY for the type of chassis being used.

Availability to BMC

Since the BMC is the high-speed data path on the MV class machines, an increasing number of devices need access to it. The SCZ-4 can only operate on the BMC. When planning slot location for the SCZ-4 controller, availability of a BMC connector to that slot is as important as finding one that is I/O ONLY.

Priority Must be Maintained

There are two signals on the Data General backplane that aid the system in deciding which board gets access to the Data Channel bus. These are: Data Channel (DCH) Priority, and Interrupt Priority. Even though the SCZ-4 does not operate on the DCH bus, the signals must be available to pass to the next controller. For this reason, it is important to add jumper wires from Priority Out of the controller before the gap to Priority In of the one after. Figure 2.1.1 demonstrates this.

Pin-to-Pin Connections

Pin # A93 (DCH OUT) goes to Pin # A94 (DCH IN)

Pin # A95 (INTERRUPT OUT) goes to Pin # A96 (INTERRUPT IN)

The result of improper jumpering will be a non-functional subsystem.

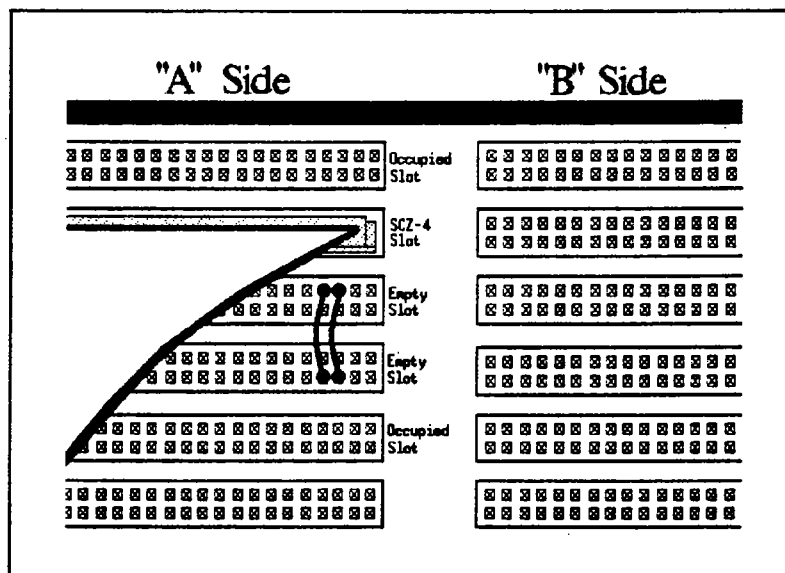

Figure 2.1.1
Backplane Priority Jumpers

2.1.2 Jumpers & Switches

Most option setup for the SCZ-4 is handled by programming the E²PROM on the controller. The controller options handled in hardware are configured via the switchpack on the front of the board. There are three: system device code, E²PROM write disable, and configuration over-ride. Also, the paddleboard has one jumper that determines the source of SCSI terminator power.

Choosing the Device Code Address

The device code is the address by which the controller will be known to the system. This address must be used in the VSGEN process discussed in Section 2.2.4. The standard primary device code used with the MTJ driver is 23₈, the standard secondary device code is 63₈. Any device code not already in use may be selected, however.

The switchpack used to set the controller device code is located on the front of the board. This fact makes changing the controller device code easy, even after installation into the computer chassis. Switches 3 - 8 of the switchpack are used to set the octal device code value. Switch 1 either initiates a self-test loop or overrides the set configuration facts stored in E²PROM. Switch 2 is for enable/disable of the E²PROM write protect. See Figure 2.1.2 for complete instructions.

When to Use the E²PROM Write Disable

The E²PROM on the controller stores information necessary for proper subsystem functioning. To completely protect this data, the option to disable writes to the E²PROM is available. In future installation steps some of this information may need to be modified to tailor the SKT subsystem to the system into which it's being installed. At this time, leave switch 2 in the UP position to allow writes until installation is completed.

Using Configuration Over-ride

The leftmost switch on the switchpack (S1) can be used to set the drive-related options stored in the SCZ-4 E²PROM to a known value. When you use the switch, logical unit 0 will be configured as SCSI ID 0. No other units will be configured.

When you are booting the software support tape you must boot from Unit 0. This switch can be used to make sure the controller will recognize Unit 0 so you can boot the Configurator program.

TO USE:

1. Power-up the system.
2. Wait 30 seconds for the SCZ-4 self-test to complete, as indicated when the LED's are no longer lit.
3. Flip S1 UP.

If you have this switch UP before power-up or during self-test, the controller will loop on self-test.

Note:

Switch Down = Binary 1
 Switch Up = Binary 0
 Switch 3 = Most Significant Bit
 Device Code = 24 Octal is Shown
 Switch 2 = EEPROM Write Disable (DOWN)

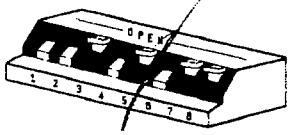

Device Code	S1 Over-ride	S2 EEPROM WRITE DISABLE	S3 DS0	S4 DS1	S5 DS2	S6 DS3	S7 DS4	S8 DS5
0X			UP	UP	UP			
1X			UP	UP	DOWN			
2X			UP	DOWN	UP			
3X			UP	DOWN	DOWN			
4X			DOWN	UP	UP			
5X			DOWN	UP	DOWN			
6X			DOWN	DOWN	UP			
7X			DOWN	DOWN	DOWN			
X0						UP	UP	UP
X1						UP	UP	DOWN
X2						UP	DOWN	UP
X3						UP	DOWN	DOWN
X4						DOWN	UP	UP
X5						DOWN	UP	DOWN
X6						DOWN	DOWN	UP
X7						DOWN	DOWN	DOWN

Figure 2.1.2
 Device Code Switches Located on Controller

3568

2.1.3 Installing Controller and Paddleboard

The physical placement of the controller and paddleboard into the computer requires care and patience. Placement of the paddleboard is especially tricky. You will need an assortment of tools and may also find a flashlight to be helpful.

How to Properly Install the Controller into its Slot

1. Pull out the locktabs at the front corners of the controller until they stick out straight in front.
2. Carefully guide the controller into the chosen I/O **ONLY** slot until the locktabs snap around the front of the chassis frame.
3. Gently apply pressure to the locktabs. The pressure you apply is forcing the goldfingers of the controller into the backplane socket. **DO NOT** apply undue pressure. If you don't feel the controller "give" a little as you are pushing it in, you may have the board misaligned. Remove and try again.
4. The board is properly installed if the locktabs end up flat against the board.

If you are inserting the SCZ-4 into the middle of a group of boards, you may need to extend the adjacent boards level with the SCZ-4 and insert them as a group.

How to Properly Install the SKT-2300 Paddleboard

1. Determine the "A" side of the backplane. Viewed from the rear, the "A" side is on the left for a chassis with horizontal boards or on the top for a vertical board chassis.
2. Locate the two rows of pins on the "A" side that correspond to the slot the SCZ-4 is installed into.
3. Check for and carefully straighten any bent pins. You will probably need to use a different slot if any of the pins are broken off.
4. Position the paddleboard connector block to cover all 100 pins of the "A" backplane. Be sure that the component side of the paddleboard is facing up.

5. Press the connector squarely over the pins, making sure all pins insert and do not bend, until the connector block is flush with the backplane. Although an amount of pressure is necessary, **DO NOT FORCE**.

CAUTION:

Component damage may occur at power-up if paddleboard is misaligned.

1. **Check BOTH ends for non-inserted pins.**
2. **Doublecheck that the block is positioned over the correct two rows of pins, and NOT between slots.**
3. **It may be necessary to count pairs of rows to determine correct positioning.**

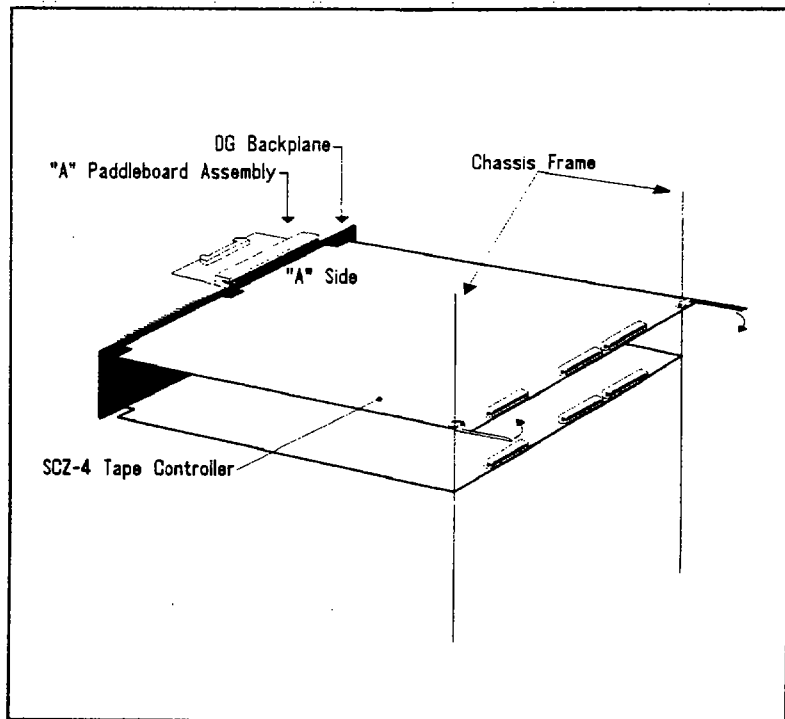

Figure 2.1.3
Installing the Paddleboard
and Controller

2.1.4 Setting up the Cartridge Tape Drive

The SKT-2300 Cartridge Tape Drive is easy to install and set up. It is a stand-alone unit with native intelligence. There is no rack mounting hardware and the only switches to set are those that tell the drive what unit you want it to be.

How to Access the Unit Select Switches

The switches are on the rear of the drive, inside the enclosure. There are two ways to get access to them.

One way to get to the unit select switches is to remove the shell of the enclosure. This involves removing three screws and pulling the shell forward. You will need a number T15 Torx screwdriver to remove the screws as they are not standard phillips or slot type.

The other way to set the unit select switches is through a small access door in the enclosure back panel. This is held in place by a single, standard-slot screw. You will need a flashlight and a thin tool about 5 inches long to flip the correct switches.

Setting the Switches

There are three switches used to select the SCSI Unit ID. They correspond to the binary place values of 1, 2, and 4. A logic level of 0 corresponds to the switch OFF position, which is DOWN.

For a SCSI ID of 0, all three switches would be down. For a SCSI ID of 1, the leftmost switch would be UP and the other two DOWN. Figure 2.1.4 demonstrates all eight possible SCSI ID switch settings.

Apply Power to the Tape Drive

You will need to plug the drive into a standard outlet. Press the Power On switch at the back of the unit. On the front panel lower left corner, a green *Power* LED should come on and remain on as long as the unit has power.

See Section 3.1 for drive power-up error interpretation.

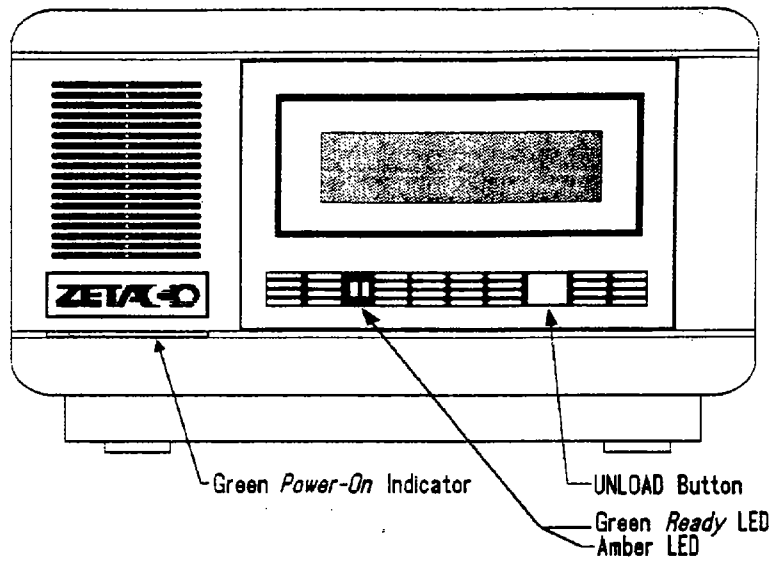
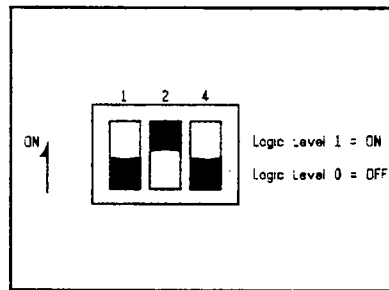

Figure 2.1.4
Tape Drive Front Panel

Table 2.1.4
SCSI ID
Switches



SW 1 SCSI ID Setting			
SW1-1	SW1-2	SW1-3	ID
OFF	OFF	OFF	0
ON	OFF	OFF	1
OFF	ON	OFF	2
ON	ON	OFF	3
OFF	OFF	ON	4
ON	OFF	ON	5
OFF	ON	ON	6
ON	ON	ON	7

2.1.5 Using the 8mm Cartridge

The small, high capacity tapes used in the SKT-2300 are easy to install and use.

The Write Protect Tab

The cartridge tape can be made read-only or writable by moving a tab on the cartridge itself. It must be removed from the drive to do this. Use a tool such as a ball point pen to move the tab.

If red is visible in the recessed area at the bottom of the cartridge, the tape is *write-protected*. You will not be able to write on it or erase it. If no red is visible in this area, the tape is *write-enabled*. See Figure 2.1.5.

Cartridge Tape LOAD & UNLOAD Procedures

To **LOAD** the data cartridge into the drive:

1. Set the write protect tab the way you want it.
2. Press the button switch on the front panel to open the access door if it is not open.
3. Insert the cartridge, label side up, lid side first.
4. Gently close the access door. The drive will automatically load the tape.

To **UNLOAD** the data cartridge from the drive:

1. Press the button switch on the drive front panel. The green *Ready* LED will go OFF.
2. The drive will rewind the tape, unload, and eject the tape unless the drive is not turned on, or the drive is active with a SCSI command.

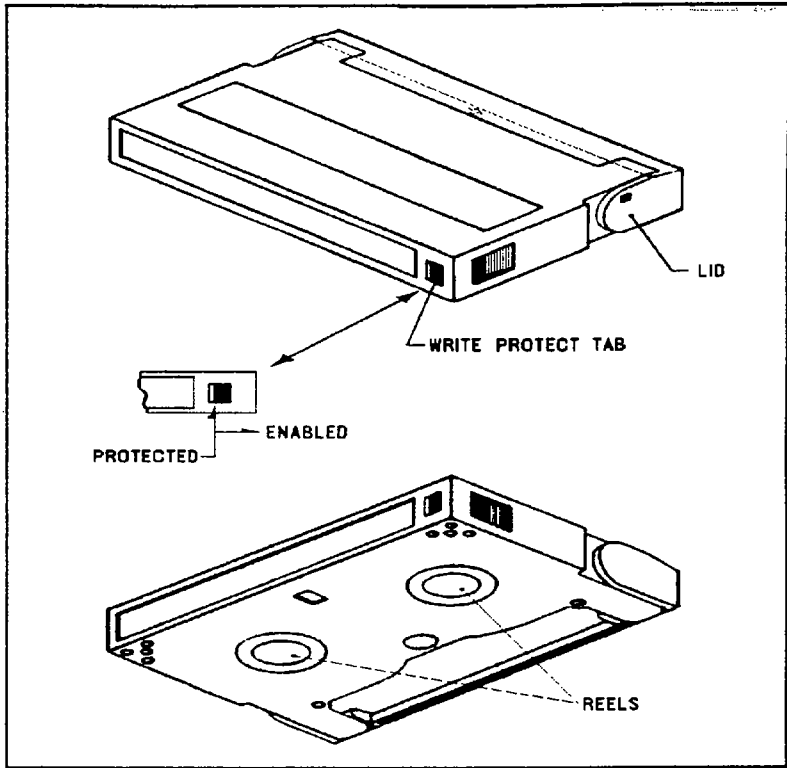

Figure 2.1.5
Location of Write Protect Tab

2.1.6 Using More Than One Cartridge Tape Drive

How Many Drives can be Added?

You may have several Cartridge Tape Drives on one SKT-2300 SCSI bus. There is a limit to the cumulative length of the cables, however. Also, the last drive only must be terminated.

The SCZ-4 Controller is fully able to support up to seven cartridge tape drives. At this time, the MTJ driver under AOS/VS only recognizes four logical units per device code. Under DG/UX, the maximum is two. Each drive, and the controller, must have a different SCSI ID.

The cumulative cable lengths of all drives attached to one controller must not exceed 25 meters. (The SKT-2300 is a differential subsystem. The cable length limits given here are per differential SCSI specifications.) There is cabling inside each drive enclosure box; this amount must be included in the total also.

With shielded cables, a characteristic impedance of greater than 100 *ohms* is preferred. It is best to use cables of the same characteristic impedance on the same bus. This minimizes discontinuities and signal reflections. Call a Zetaco representative for more information on available cables and lengths. Do not exceed the maximum cumulative length of 25 meters.

Figure 2.1.6 depicts a series of cartridge drives. Add the cable lengths using the following formula to determine whether you are over the limit. (To convert to feet, 39.37 inches are in one meter.)

n = number of devices on bus
L = length of cables between devices

$(.7 + L1 + L2 + \dots Lx) + n(.3)$ must be ≤ 25 meters

1. Add together all the lengths of shielded cables for all drives including the cable from the computer chassis. Also include the seven tenths of a meter of ribbon cable used inside the HOST chassis.
2. Multiply the number of tape drives by three tenths. This represents the fraction of a meter length found inside each drive enclosure.
3. Add the two numbers. The total must be equal to or less than the 25 meter limit.

Terminate the Bus

The SCSI interface requires termination at both ends of the bus. The paddleboard is terminated on the controller end and the last drive must also receive termination. Install the terminator plug provided with the subsystem in one of the connectors on the back of the last drive. See Figure 2.1.6.

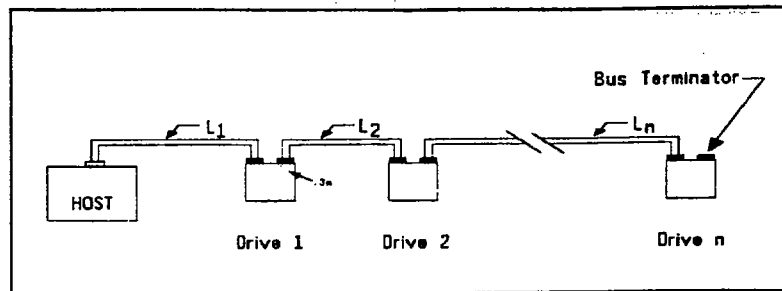

Figure 2.1.6
Daisy-Chained Tape Drives

2.1.7 Where to Use the Cables You Received

The cable going out to the drive comes in two parts: internal and external. The separation occurs at the chassis bulkhead to comply with FCC regulations. Extra external cables are needed to cable to more than one device. BMC cables provide the only bus the SCZ-4 can use for data transfer.

Connecting Internal & External Drive Cables

The internal cable is designed to plug into the paddleboard on one end and mount on the chassis bulkhead on the other end. The internal cable is made from ribbon cable and the external cable is made from shielded round cable. The external cable fits to the SKT-2300 tape drive. To install both:

1. First, remove the cover from a mounting hole on the bulkhead and remove the bolts, washers and nuts from the D-connector end of the internal cable.
2. Insert the connector into the mounting hole from the inside and fasten with the bolts from the outside.

NOTE If the computer is non-FCC-compliant, there will be no bulkhead. You must fasten the internal cable to the external cable with a non-bulkhead installation kit available from Zetaco.

3. Plug the other end of the internal cable into the paddleboard installed on the backplane.
4. Fasten the mating end of the external cable to the D-connector of the internal cable mounted through the bulkhead.
5. Fasten the other end of the external cable to the tape drive enclosure.

Providing Access to the BMC Bus for the SCZ-4 Controller

Since the BMC is the high-speed data path on the MV generation of computers, an increasing number of devices require access to it. Chances are that BMC cables are already in place on the system. If so, insert the free connector of each cable into the SCZ-4.

If the SCZ-4 is the first BMC device to be installed in the system, you must use the provided cables. See Figure 2.1.7.

The standard Zetaco BMC bus cables have 4 connectors to access BMC devices; cables with 6 and 8 connectors are also available.

1. The ends of the cables with a single connector go to the system BMC controller. Pay attention to Pin 1 orientation as you insert.
2. The other end of each BMC bus cable will have a group of connectors designed to be inserted into different BMC accessing devices. Insert one connector from each cable into the sockets provided on the SCZ-4.

Providing Termination for the BMC Bus

Each SCZ-4 Controller is shipped with a BMC terminator installed. Figure 2.1.7 shows the location. Only the last device on the BMC should be terminated. Remove the terminator plug from the SCZ-4 if it is not the last device on the BMC.

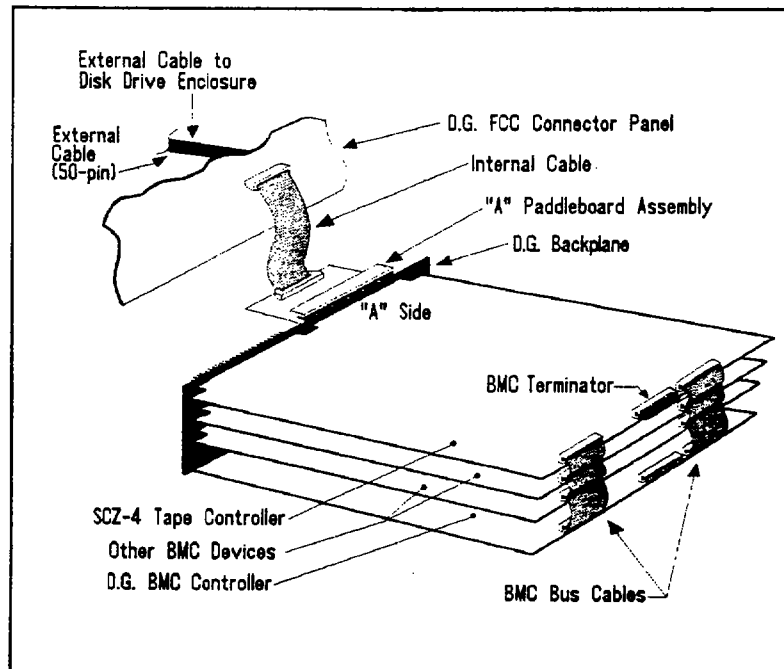

Figure 2.1.7
SCZ-4 Cabling Diagram

2.2 *How to Check for Normal Power-Up*

Before going on to the software part of the installation, you must make sure the hardware is working properly. The best way to test for initial problems is to turn on the power.

Both the controller and the drive go through power-up self-test. Other system devices, including the CPU, do this too. When a SKT-2300 Subsystem is functional, you should see:

1. All SCZ-4 LEDs will be out after 30 seconds.
2. On the tape drive, both green LED's will be ON, signifying the drive has power, a tape is loaded, and that the drive is ready. (The amber drive LED will be OFF.)

When an MV system is ready, you should:

1. Have a system prompt on your CRT screen.
2. Be able to enter commands onto the screen and get system response.
3. Be able to load system microcode to make the system functional.

As an installation aid, refer to the Checklist in Table 2.2. If your subsystem did not power-up correctly, look through the checklist for omissions or go directly to the TROUBLESHOOTING section of this manual. If the system is acting strangely, refer to the proper Data General documentation.

**Table 2.2
Hardware Installation
Checklist**

Check here: If:

	<p>Slot is I/O ONLY</p> <p>Slot has DCH and Interrupt Priority to it</p> <p>Device Code switches are set</p> <p>E²PROM Write is Enabled (Switch 2 is UP)</p> <p>Controller inserted tightly (locktabs flush)</p> <p>Paddleboard is installed on "A" Side</p> <p>Paddleboard covers all 100 pins</p> <p>Paddleboard aligned to correct slot</p> <p>Ribbon cable installed in paddleboard</p> <p>Shielded round cable goes to drive</p> <p>BMC cables installed to correct devices</p> <p>BMC terminator installed on last BMC device</p> <p>BMC terminator removed from SCZ-4 if not last</p> <p>Tape is loaded into drive</p> <p>Green drive LED is ON</p>
--	--

2.3 The Software Installation Process

The software focused on here is the software necessary to complete the integration of the SKT-2300 into your system. You will need to configure the Controller, run tests, and enable the driver under the operating system.

The majority of the information is about the programs written by Zetaco specifically for our product. The Data General system program, VSGEN (or its equivalent in DG/UX) must also be run. The Data General programs, CONTEST, MV/SYSTEMX, and MLTT RELI are also tools for your use. Details on how to use these programs are not available here, only information on when their use is appropriate.

The following sections may be followed step-by-step in the order presented.

1. Using the Support Package Tape.
2. Using the Configurator program to set options.
3. Using the Reliability program for test.
4. Preparation under the Operating System.

Have Enough Reference Material Ready

It is always appropriate to have Data General documentation on hand when installing something new. If you are running AOS/VS, it would be especially valuable to have the Data General guide:

"How to Generate and Run AOS/VS."

The chapter on using VSGEN will be especially useful when performing the fourth step listed above.

If you are using DG/UX, these two references may be helpful:

"DG/UX System Administrators Guide"

"Installing and Managing the DG/UX System"

If you have access to documentation on the Data General test programs available with the system, have that on hand also.

**System
Requirements
for
Installation**

- An MV family CPU running AOS/VS or DG/UX with minimum 32K words of memory and MTJ driver available.
- Console at Device 10/11.
- Printer at Device 17 (if error log and configuration fact copies are desired).

2.3.1 Using the Support Package Tape

There are two important tools supplied on the Support Package Tape. With the Configurator program you may alter information stored in the E²PROM on the controller according to your needs. The Reliability program automatically performs a series of tests on the subsystem.

What the Files on the Tape are For

The Support Package Tape is structured so that the programs on files two and three can be loaded and executed directly from the tape. Each is a stand-alone program; neither can be run under the operating system.

The fourth file on the tape contains copies of the Configurator and Reliability programs in a format suitable for booting from an AOS/VS system disk instead of the tape. This does not mean that either of the programs can run under AOS/VS, only that they are bootable from the disk (which makes bringing up either program faster). Instructions on how to use this file come in a later section.

Files 0 and 1 on the Support Package tape contain special bootstrap programs that perform housekeeping to keep the system happy so the other programs can run. They also bring up the tape menu seen in Figure 2.3.1

How to Access the Tape

All SKT-2300 tape drives and the computer should be powered on and ready, with no error conditions. The next step is to access the contents of the Support Package Tape.

The Support Package software has been shipped to you on an 8mm tape that fits into the cartridge tape drive you are installing. Do the following:

1. Install the 8mm tape into the drive. Make sure you know what device code the SCZ-4 is set for.
2. Load the system microcode if you are just powering the system up. (System microcode is not necessary to run the Configurator program, but it is necessary for the Reliability program.)

3. When the SCP prompt appears, type B or BOOT and the device code of the controller being used.

```
SCP> BOOT 23 <or> B 23
```

After a time, the Support tape menu will be displayed, as shown in Figure 2.3.1.

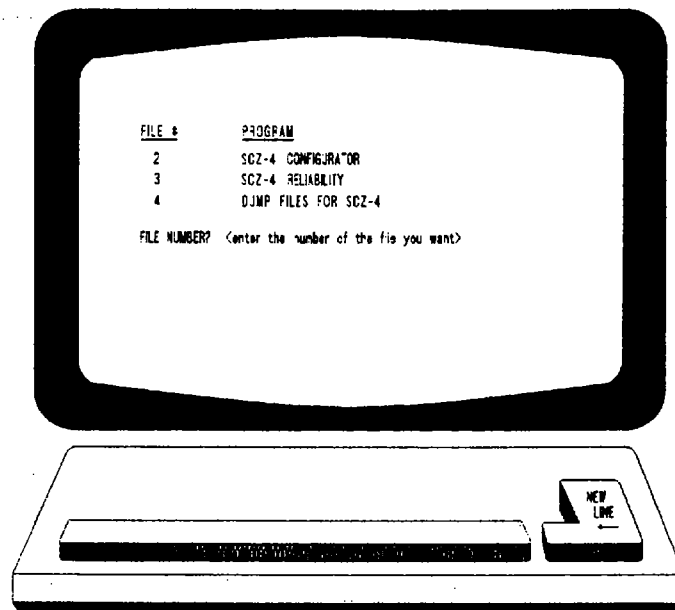

Figure 2.3.1
Menu of the Support Tape

2.3.2 Using the Configurator Program to Set Options

The performance of the tape subsystem relies on more than how fast the drive is.... it also relies on how well the pieces of the system interact together. The Configurator program provides a dialog, giving you choices on set-up, to allow you to easily change what is already stored.

The Zetaco Configurator program is designed to interact with you, help you decide what to do (if you need help), and then store your changes into the SCZ-4 E²PROM.

The Configurator is an easy-to-use program. It provides a choice whether to use it in *novice* or *expert* mode. In *novice* mode, help screens are automatically displayed. The program is menu driven, but the first full screen you see is the Configuration Overview. It is also displayed after you make changes to an option. Figure 2.3.2a shows what it looks like. From this screen you can get to the Main Command Menu. The main menu choices are shown in Figure 2.3.2b. Each main menu choice has a menu of its own.

Examine the data in the Configuration Overview. It is important to make sure that the Break Count, Burst Rate, and BMC Priority values are what you want. Also verify that the correct tape units are specified. To change any of the information in the Configuration Overview, enter the number of the main menu command or go to the Main Command Menu by pressing NEWLINE.

Selection from the Main Menu depends on what you want to do. To change BMC priority, Burst Rate, or Break Count, select:

1. Display/edit the CONTROLLER-SPECIFIC parameters.

To make a change to the tape drive choices displayed, select:

2. Display/edit the TAPE DRIVE assignment table.

NOTE While you are using the Configurator program, the controller right-hand red LED will be on steadily. This indicates that you are communicating to the SCZ-4 Controller on a hardware level. When you have finished making your changes and exit the program, the red LED will go out.

After you are done making your changes to the E²PROM Configuration, be sure to update the SCZ-4. This is choice 9 from the Main Menu. You should also flip the E²PROM disable switch (S2) DOWN to protect the E²PROM contents.

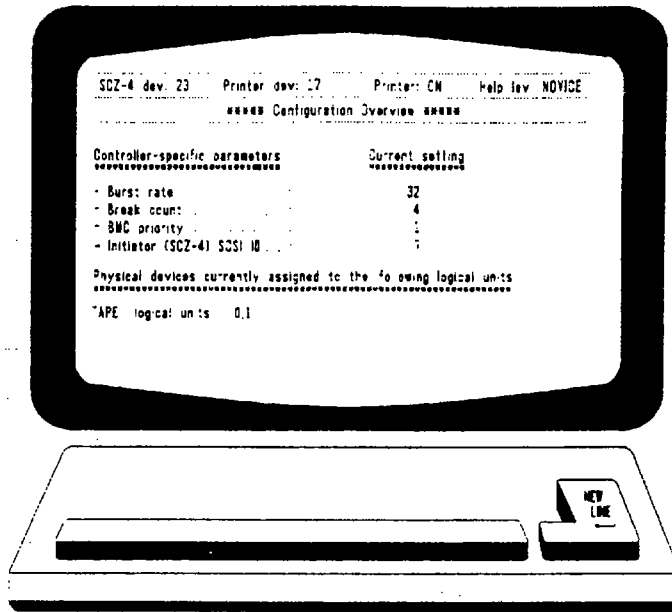

Figure 2.3.2a
 Configuration Overview Screen

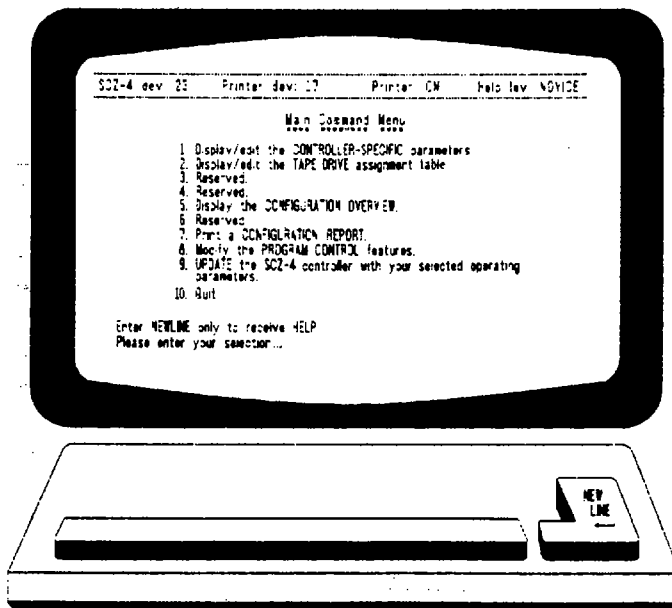

Figure 2.3.2b
 Configurator Main Menu

2.3.3 More Information on Which Options to Change

Anytime you add to a system, you change the interaction of the parts. Try to make the transition painless by choosing the set-up options intelligently.

BMC Options

How you select the values for these options will affect how well the new controller gets along with those already there. Base your decisions for these values on:

1. How much system-wide traffic the Controller will be asked to handle.
2. When the Subsystem will get the most use. After or before hours? During peak worktime?

BMC PRIORITY: Choose a number between one and seven. The higher the number given to a Controller, the more weight the Data General BMC Controller gives to its request for bus access. (On the MV/4000 you must choose between zero and three.) There can be no duplication or the system will get confused.

RECOMMENDATION FOR SCZ-4: Since the use for this tape device will be mostly back-up, probably performed during a low use time, a lower BMC Priority is acceptable.

BMC BURST RATE: This value can be 2, 4, 8, 16, 32, 64, 128, or 256. This is the number of words that can be transferred by the Controller per BMC bus request. After the transfer limit has been reached, the Controller must relinquish the bus and wait to try again. A low value may make data transfers take a long time, decreasing performance. A high value may dominate the bus, causing data late problems with other controllers.

RECOMMENDATION FOR SCZ-4: Of course it depends on your system usage, but a good number to begin with is 32.

BMC BREAK COUNT: Choose a number between one and 256. This sets the amount of time the controller waits between data transfers, before trying to get access to the BMC bus again. Basically, this number tells the Controller how many BMC Sync Clock periods it must count before making another BMC request.

Try to balance this number with the BMC priority selected. A high priority device with a small Break Count will be on the bus a greater amount of time, possibly excluding others.

RECOMMENDATION FOR SCZ-4: A good number to start with is four. Your first thought may be that since the peripheral you are installing is a tape drive, you must make allowances for its slower speed when setting the options. This may be true with non-intelligent drives, but the SKT-2300 employs the SCSI bus, which has the capability to accept a command, and disconnect from the Controller while it is performing the task. The Controller does not spend any BMC time waiting for more data from the Tape drive.

<u>BMC OPTION:</u>	<u>WHAT TO REMEMBER:</u>	<u>RECOMMENDATION:</u>
Priority	- Want highest numbers assigned to the most intensively used devices. - DO NOT DUPLICATE	Lower Number Okay
Burst Rate	- Low value on high traffic device could cause lowered performance. - High value can cause device to dominate BMC bus causing data late on others.	32
Break Count	- Balance this number with priority of the device. - Too high a value may degrade drive-to-controller performance.	4

Selecting SCSI ID for the SCZ-4

A SCSI bus can support up to eight devices. Communication on the SCSI bus is allowed between only two devices at a time; one acts as an initiator and the other acts as a target. The initiator (typically a controller such as the SCZ-4) originates an operation and the target performs the operation. Each device has its own SCSI ID. The SCZ-4 is counted as one of the eight possible devices. It is through the Configurator that you choose which ID to make it. The ID numbers are weighted, with more priority going to the higher number device during certain bus phases. **SCSI ID seven is recommended for the SCZ-4. Be sure that there are no duplicate ID's on the bus.**

2.3.4 Using the Reliability Program

The function of the Reliability program is exactly what its name implies: it tests that the drive and controller are operational, and that extended use with combinations of commands does not make them fail.

As a stand-alone program, the Reliability utility tests only the part of the system that you are installing. No attempt is made to provide an exhaustive system level test. It does not, for example, tell you if you have duplicated BMC priorities. To test for system level functioning, run Data General's MVSYSTEMX.

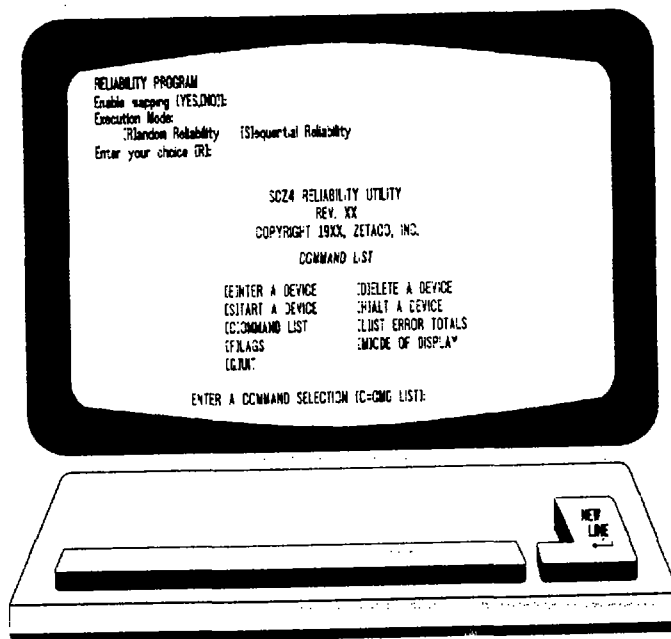

Figure 2.3.4
Main Menu of Reliability Test Program

Choosing the Program Global Parameters

Before you get to the Main Menu, you are asked to choose several global operating parameters. These choices are asked only when the program is booted or restarted. The parameters are for: Mapping and Program Execution Modes.

Mapping

Enabling this feature allows the Reliability program to test some of the mapping features for which the SCZ-4 is responsible. These features are defined in the Data General Programmer's Reference series. It is not necessary to enable mapping in order to test controller-drive functionality. The default answer is no. **DO NOT enable this mode if running in an MV/7800 or MV/4000.**

Program Execution Modes

You may choose to run in sequential or random mode. In sequential mode, continuous writes of a fixed size are performed to EOT, the tape is rewound and a read to EOT ensues, if verify is enabled.

In random mode, a variable number of records containing a various number of bytes is written to a file. It is immediately read and verified (if enabled) and the program continues. Sequential takes about 2 hours to complete a small tape. Random will continue until stopped.

The Program Sequence to Follow

Basically, when you run the program, you:

1. Select the global program parameters. Random Mode with no mapping is a good choice for first installation. Let the test run for 20 minutes.
2. Enter the devices you want to test and the test specifics for each of them. Use the [E] command from the main menu.
3. Run the tests. Use the [S] command.
4. Examine the status of each drive. Use the [L] command.

See Section 3.4 for information on error messages from this program.

2.3.5 Summary of Reliability Commands

Use this explanation of each Reliability command to better understand how to use the program.

The Main Menu Options

1. **ENTER A DEVICE** – This command does several things:
 - a) Initializes the Controller.
 - b) Looks for READY units – You may operate on any drive that appears READY to the Controller. The program reports, starting with UNIT 0, that a drive is ready and allows a YES/NO choice for selection.
 - c) Sets Test Parameters – After accepting a READY unit for testing, the program asks for input about the records the test will write. If you have selected **Random Mode** previously, the program will need to know the maximum number of records it can put in each file and the maximum number of bytes each record can contain. If you selected **Sequential Mode**, the program will request only the fixed number of bytes to put in each record. A Default value is given for each question.

Next, the program accepts YES/NO choices for Write Only, Read Only, and Verify Data. (Read ONLY occurs with sequential mode only.) You also must choose one of nine data patterns to write/read. After each READY unit that you wish to run has its test parameters defined, the program returns to the command prompt. To actually begin the tests you have selected, use the **START** command.
2. **START A DEVICE** – This command gives you the option of starting the test on all entered devices, or on any combination of them. To verify that the program is running, observe the green LED's on the controller or issue a **LIST** command.
3. **LIST ERROR TOTALS** – This command lists status and error information. It can be used any time you wish to find out about the devices running. If you use the command before issuing a **START**, the information about mode will be accurate, but the runtime, blocks written and read, and error totals will not.
4. **COMMAND LIST** – This command displays the Command Menu.

5. **HALT A DEVICE** - Any device can be halted without affecting tests being performed on other devices.
6. **DELETE A DEVICE** - Once you HALT a test being run on a device, you can delete that device from the testing altogether, by using this command.
7. **PRINTER CONTROL** - This command enables or disables the printer. If the program is running unattended, enable the printer so you can capture error messages. Use of this command does not affect tests being run. A program RESTART will put it back to the default of disabled printer.
8. **RESTART THE PROGRAM** - This command completely reinitializes the program. You must reselect mode, devices, and reenable the printer.
9. **FLAGS** - The flag available in the Reliability program can be set to halt the program when an error is encountered or, the default, simply log the error and continue. If you choose to halt at an error condition, the program will log the error and jump to the Debugger resident in the program. To leave the Debugger, and restart the program, type RT. The flag may be changed while tests are running.
10. **QUIT** - This command gets you out of the program.
11. **MODIFY DISPLAY MODE** - You can choose to use hexadecimal, decimal or octal for program display and input.

2.3.6 Preparation Under the Operating System

Any controller and drive being added to a Data General system needs to be made recognizable to the system software. This is done using the VSGEN program provided with AOS/VS system software or using the sysadm program under DG/UX. Zetaco products are compatible with either process. Also, files from the Support Package tape may be loaded onto an AOS/VS system disk for ease of future use.

Why Run VSGEN or sysadm?

All hardware in a system needs to be unified in some way in order to work together. This is the job of the system software, or Operating System. There are several layers of complexity to this software. That software closest to the hardware is often said to DRIVE the hardware. It knows about the bit meanings of status returned and how to tell the hardware what to do. This software is referred to as a DRIVER. All pieces of hardware need a Driver to interpret and translate for it.

The purpose of the program VSGEN or *sysadm* is to select the Driver compatible with the hardware you are installing.

What to Know Before You Run VSGEN or sysadm Programs

You need to know:

1. What device code you have set the hardware to.
2. The Driver to select is called MTJ.
3. The name of the configuration file to edit for additions.
4. The unit number of the tape drives.

For further assistance, consult system management documentation.

**Loading
Support Tape
Files Onto an
AOS/VS
System Disk**

The last file on the Support Package tape is in DUMP format. This means that it is recognizable to the system LOAD program.

If you load this tape file into the root directory, both the Reliability and Configurator programs will be available to load when the system prompts for a file name. These are the file names to use:

Configurator CFSCZ4.SV
Reliability SCZ4R.SV — *DIAGNOSTICS*

Note that if you are in any other directory when you read this file in from tape, the programs will reside in that directory and the directory name becomes a part of the filename necessary to bring up the program. For example, if you loaded them under the UTIL directory you would boot this filename to get the Configurator:

:UTIL:CFSCZ4.SV

You will be loading the program off the disk, from the directory UTIL.

Currently, the option to load Zetaco's Support Tape files to disk is not available for DG/UX.

**Standard CLI
Commands to
Load File 4**

To load the programs onto the system disk as described, follow this script:

```
SUPERUSER ON  
DIR : **or other directory you want it to be in  
LOAD_II/R/V @MTJ0:4  
REW @MTJ0  
SUPERUSER OFF
```

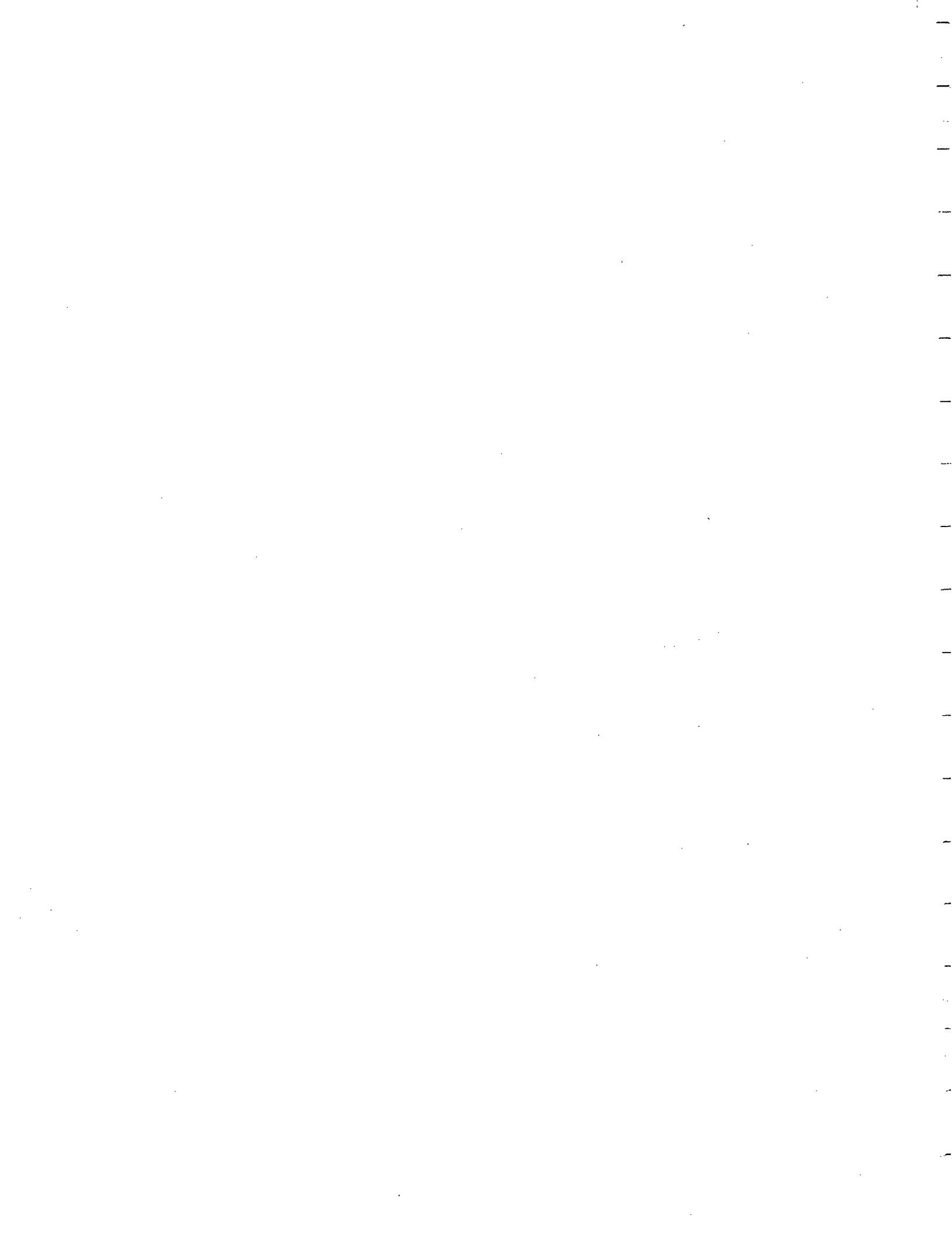

3.0 Troubleshooting Subsystem Errors

Problems can occur with any controller and drive. They may occur during initial installation or after a period of time. Most installation difficulties are apparent at the first power-up or while performing installation set-up and test procedures using the Support Package Tape. Problems that occur after a time of successful usage are more likely to take the form of system error messages. Troubleshooting under the operating system is difficult if not impossible. It is best to rely on stand alone test programs such as Zetaco Reliability or Data General MVSYSYSTEMX for help.

Power-up Problems

You must be aware of equipment failure messages at the crucial time of applying power to the subsystem. In this matter, the hardware is supported by:

- Microprocessor based controller self-tests performed each time power is applied
- Controller LED status indicators for self-test
- Tape drive self-test at power-up
- LED status from tape drive

Test Programs to Use

The SKT-2300 has its own test program, written specifically for it and easy to use. It should be used during installation and may also be used at any time problems are suspected. Data General programs such as MVSYSYSTEMX and MLTT RELI and CONTEST may also be used on this Zetaco product and can be useful to diagnose unclear system errors.

Distributor Support

Zetaco provides support through authorized distributors with:

- Quick turnaround for factory repair/replacement
- Warranties on workmanship and materials

3.1 Interpreting Tape Drive Faults at Power-Up

The tape drive goes through a self-test every time it is turned on. If all tests do not pass, the two front panel LED's will flash.

Normal Power-Up Initialization

To determine whether the power up of the drive is normal, look for the following to occur:

1. The amber and green LEDs are both on during the self-test diagnostics.
2. Both LEDs should be on for about one minute.
3. After self-test, both LEDs will turn off.
4. If a tape is in the drive, the drive will take about 8 seconds to position at Logical BOT. You will be able to hear it working.
5. Once the tape is at LBOT (Logical Beginning of Tape), the green LED alone will go on to indicate READY status.
6. If no tape is in the drive, both LEDs will remain off until a tape is inserted.

The green LED on, alone, means the drive is loaded with a tape and is ready for a command. The amber LED flashing, alone, means there is activity on the SCSI bus. Both the green and amber LEDs flashing means self-test diagnostic has failed. See Table 3.1.

Self-test That Does Not Complete

If self-test finds a problem with one of the drives functions, the LEDs will flash. If both LEDs stay steadily lit for more than a minute, self-test is not completing properly. This could be because the paddleboard is hooked to an empty slot, and therefore not aligned to the SCZ-4. If this happens, check the controller-to-drive path: paddleboard and cables.

**Table 3.1
Definition of
Tape Drive
LEDs**

LED Activity	What It Means	What To Do
Both ON steadily	Self-test running	NORMAL; 1 minute. If longer, check paddleboard location.
Both OFF	Self-test OK, no tape	NORMAL; load a tape
Both FLASHING	Self-test FAILED	1. Retry power-on 2. Call for assistance
GREEN only ON	Drive READY, tape LOADED	NORMAL; continue using
AMBER only FLASHING	Drive is working	NORMAL; continue using

3.2 Interpreting Controller Self-test Errors at Power-Up

Self-test resides in ROM on the controller. It is designed to check the most critical functions of the hardware each time power is applied. Self-test is actually composed of two independent modules, each consisting of a series of tests and each associated with a group of three LEDs on the front of the board.

There are six LEDs on the controller, grouped by three. Each group is a series of red, green, and yellow. See Figure 3.2 to identify LED placement on the Controller board.

The entire test takes about 15 seconds to complete. While Self-test is being performed, both red LEDs and the leftside yellow one will be lit. If self-test was successful, all LEDs will go out.

If the LEDs remain on for a time longer than self-test should take, the Controller may not be seated correctly. If a portion of the Hardware is defective, an error sequence will flash on the LEDs.

Table 3.2 explains what can be done in each of these instances.

Table 3.2
What the
LEDs Mean

SYMPTOM	WHAT TO TRY
Both RED and leftside YELLOW LEDs steadily lit.	Re-seat controller or install in another slot.
A pattern is flashed on the LEDs.	Retry power-up. Record error code. Call for Assistance.
All LEDs extinguished.	Don't do anything! This is normal.

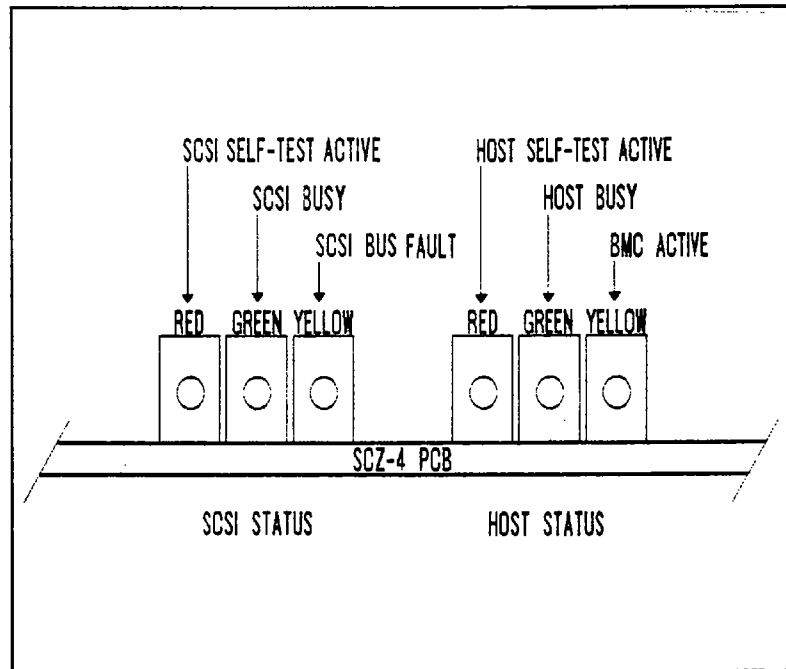

Figure 3.2
LED Status Indicators

3.2.1 Identifying the Self-test Failure

There are two sets of LEDs that reflect the status of the two parts of the board. The rightmost LEDs report the status of the tests performed on the Host logic, which is responsive to the Data General Argus driver. The leftmost LEDs correlate to the tests performed on the logic controlling the SCSI device(s). Each side has a different way to report a test that fails.

Host Side Error Decoding

When the Host side logic errors during self-test, the red LED on the right flashes. The number of times it flashes between pauses corresponds to the number of the test that failed. Possible test failures are displayed as follows:

<u>RED LED FLASHES:</u>	<u>TEST THAT FAILED:</u>
1	Ram Test
2	High Speed Buffer Bank0
3	High Speed Buffer Bank1
4	Done Flip/Flop
5	Burst Counter
6	Break Count
9	E ² PROM Checksum
10	Dual Port RAM
11 - 20	Decimal Value of SCSI Side Failure

SCSI Side Error Decoding

The numbering of the SCSI side tests is in octal. They are all two digit numbers. All three of the LEDs on the left are used to indicate the octal number of the test that failed, not just the red LED.

The octal number is displayed in binary format on the LEDs. Since the highest single digit in octal is seven, three LEDs are enough to transmit the code of the failing test, one digit at a time.

Figure 3.2.1 shows the octal value represented by the LEDs. Follow this procedure to decode them:

1. Watch for all three LEDs to light in sequence, right to left. This marks the beginning of the code sequence.
2. Observe which LED lights next and record its value as the Most Significant Digit of the code, determined from Figure 2.3.1.

3. After a blank pause, one or more LEDs will light, or none, representing the value of the Least Significant Digit. Record this value next to the first.
4. After another blank pause, the beginning sequence will reoccur, and the code will repeat. These are the possible SCSI side test failures that may occur:

<u>DIGITS FLASHED:</u>	<u>TEST THAT FAILED:</u>
13	Error programming the Gate Array
14	Error reading back/verifying the Programmable Gate Array
15	Static RAM test failed
16	BMC Buffer test failed
17	BMC Buffer parity error
20	Test of DMA Transfer Counter failed
21	Test of DMA Address Counter failed
22	Test of 80186 Timer failed
23	Test of SCSI Control Chip Registers failed
24	SCSI Hang Timer test failed

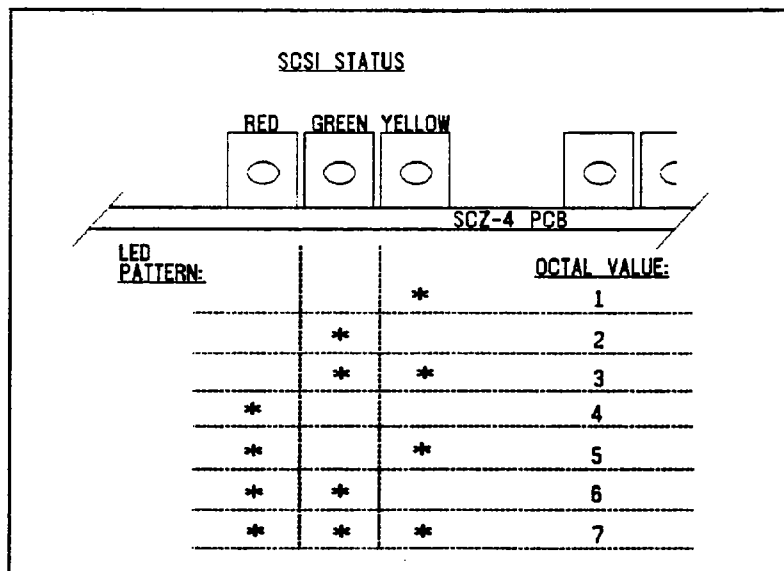

Figure 3.2.1
Getting an Octal Number from LEDs

3.2.2 Decoding LED Flashed Errors Other than During Self-test

In addition to errors that occur during self-test, there are a few errors that can occur during normal system operation. These errors are reported on the leftmost group of controller LEDs.

The SCZ-4 Controller is designed to report several kinds of hardware failure that may occur after power-up. This aids you in verifying system reported faults.

Like the SCSI side self-test failure codes, the Operational error codes are two digit octal values. (Both are under seven). To distinguish from the other, the Most Significant digit is always seven.

Follow this procedure:

1. Watch for the LEDs to light in sequence, right to left.
2. Watch for all three LEDs to light at once. (This represents a seven, indicating an operational error).
3. After a pause, the LED display will change to indicate the Least Significant octal digit. Note which LEDs light.
4. After a pause, the LEDs will light in sequence again and the pattern will repeat.
5. Find the value of the Least Significant octal digit by looking below. (The Most Significant octal digit will always be 7 for this type of error.) These are the errors that may occur:

<u>OCTAL VALUE</u>	<u>MEANING</u>
76	Illegal 80186 Interrupt
77	SCSI Side Memory Fault

If either of these error codes are flashed, record the code and call for assistance.

**Meaning of a
Steadily Lit
Yellow LED**

The error reported by this means does not indicate a Controller hardware failure. Instead, it is most likely indicative of a failure that has occurred on the drive.

A steadily lit yellow LED on the left means a drive interface fault has occurred.

In order of most likely to least likely, the cause of this failure may be:

1. Drive Related — If possible, try a different drive.
2. Cabling — Check that all cable connections are solid. Try replacing them with known good ones.
3. Controller — Try replacing the controller.

3.3 Problems Running the Utility Programs

Sometimes difficulty running the utility programs is due to operator or installation error. Sometimes it is defective equipment. There are a few things to check on first that might lead to a simple solution to a problem.

It is valuable to use the Zetaco Utility Programs, Configurator and Reliability, anytime you suspect trouble with the SKT-2300 Controller or Drive. During initial installation, they are most valuable in accessing any trouble before running under the operating system.

If you are having trouble getting the programs to run properly, there may be defective equipment, or just operator or installation error.

Assumptions About the Installation

The following information is based on the assumption that these things are true:

1. The Controller is installed in a good slot
2. The backplane and BMC priorities are correct
3. No problems exist with the computer or other peripherals

If you cannot verify these assumptions for the system you are working on, start your investigation there.

Two Common Difficulties When Running the Programs

To eliminate operator or installation error from consideration when these errors occur, try the following suggestions.

1. *Controller Does Not Respond When Selected*

This can happen with either program, but for different reasons. Most often you will see a *hang* condition after you enter the device code of the board when the program prompts for it. It is at this point that the program tries to communicate with the Controller. Anything in the path of communication between board and program is suspect. This includes backplane priority and connection, device code settings, and system microcode corruption.

2. Drives Appear Not Ready

You will only see this with the Reliability program because the Configurator only needs to communicate to the board. You don't even need to hook up the drives to run the Configurator. The Reliability program goes through an Initialization process when the [E]nter Device command is used. Part of this process is to try to access any drive for which it is configured and report back on its READY status. If a drive is not READY, the program cannot use it, and will not allow you to select it. Anything in the path of communication between the Controller and Drive is suspect. This includes cables, paddleboard, position of paddleboard, drive facts in Configurator, and SCSI drive ID settings. Whether the drive is powered down or improperly terminated could be a factor.

The same concerns and checks would be appropriate if it is the WRONG drive that appears ready.

**Table 3.2.3
Common
Problems &
Solutions
Using Utility
Programs**

IF THIS:	YOU'LL SEE THIS:	CHECK/TRY THIS:
Controller does not respond	Configurator will hang Reliability will error	1) Device code as used & as set 2) Load/Reload system microcode 3) Re-seat controller & retry 4) Has Controller self-test passed?
Drive(s) appear Not Ready	Reliability will report Not Ready Configurator doesn't care	1) Verify configuration facts 2) Replace cables to drive 3) Paddleboard installed at correct slot 4) Replace paddleboard 5) SCSI Drive ID switches are correct 6) Drive is turned on 7) Correct drive is terminated
Wrong drive appears Ready	Reliability reports wrong drive Ready Configurator doesn't care	1) Verify configuration facts 2) SCSI Drive ID switches are correct 3) Termination is on correct drive 4) ALL drives are turned on

3.4 Types of Error Messages From Reliability

Description of PIO and CB Error Reporting

Run the Reliability program anytime you need to verify the integrity of Controller-Drive communication. Using a test program such as Reliability can give more information about a problem condition existing with the subsystem.

The Reliability program uses the same command protocol, Control Block (CB) and Programmed Input/Output (PIO), as the system does. An error can occur while the Reliability test program is executing either type of command. When a Control Block has a failure, the message will look like this:

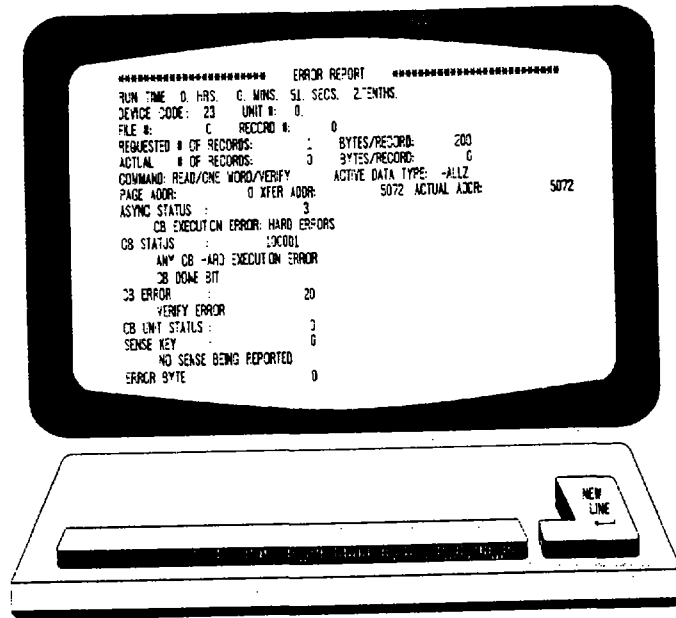

Figure 3.4a
CB Type Error Reports

A PIO command can error or never complete and the message will take this form:

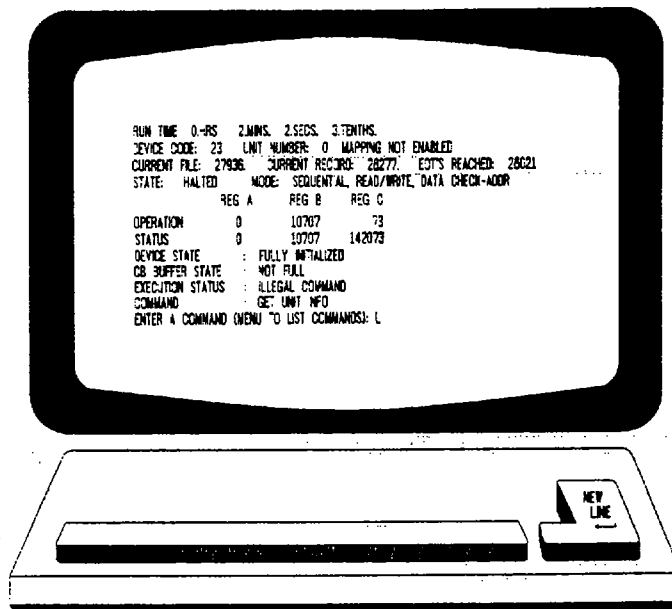

Figure 3.4b
PIO Type Error Reports

With the Reliability program it is never necessary to look up the bit meaning of status returned from the program because it is interpreted for you.

If a PIO command never completes, the controller will never issue an interrupt to report completion and a Timeout error message will be reported by the program.

Tape Hard Error Messages

As tapes are used, they develop bad spots. The tape drive has excellent ECC and a generous retry algorithm. The ECC recovers read data on bad spots. The retries ensure a good write. Therefore, a Hard Error that occurs most often would mean you should clean the tape heads or replace media.

Data Compare Errors Can also Occur

When the VERIFY option of the Reliability program is selected, the program writes data, reads it back and compares the data read into memory with what should have been written. If the data doesn't agree, an error report is generated.

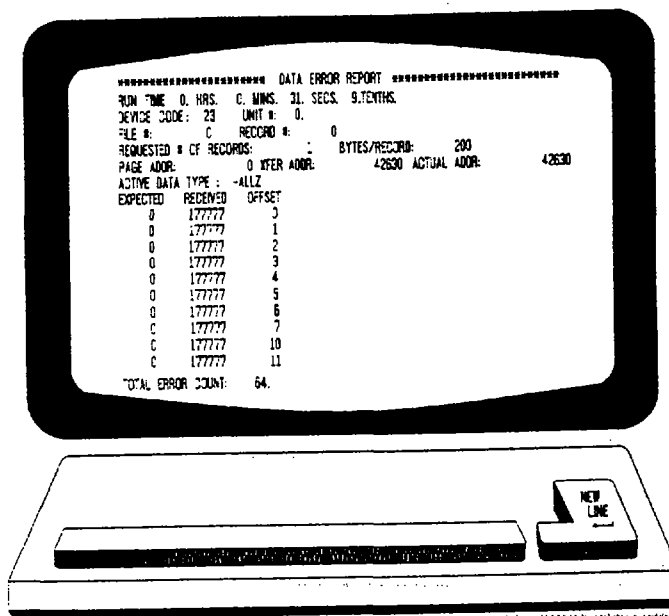

Figure 3.4c
Data Compare Error Reports

When Data Compare errors occur, the Controller is the most probable cause. You could also try different BMC cables or replace the paddleboard and cables to the drive.

This type of error does not indicate bad media or dirty tape heads; those would cause a tape hard error.

This page intentionally left blank.

3.5 Error Messages From the System

Errors that occur while running the operating system are sometimes an annoyance and sometimes a catastrophe. Depending on the problem, the system will either react gracefully by informing you and continuing, or it will crash in a PANIC state.

Recovering From a PANIC

It is difficult to know what causes a system crash. The software just gets to an operational dead-end and shuts down. A PANIC code is usually reported; it may or may not offer significant help. In this situation two things can be helpful:

1. Assuming your system once did work, look at what you have recently changed. You may have changed something significant when installing the new peripheral. It could be something in the new GEN or a serious BMC conflict. Have you modified user software? Has something in the computer environment changed: temperature/humidity or a new electrical system? Try to narrow down, focus your suspicions and eliminate possibilities.
2. If you suspect that one of the devices in the system has a hardware problem, it is beneficial to run diagnostic tests. Data General's MVSYSYSTEMX works on the system as a whole. Individual subsystems can be tested using a Reliability program such as Zetaco provides with its products.

Using MVSYSYSTEMX

This test is valuable to run because you don't need to involve your operating system (which may help to eliminate variables in troubleshooting the problem) and it tests all the hardware. It is like a mini operating system. Refer to the system user documentation for instructions on how to run MVSYSYSTEMX and interpret its error messages.

Using CONTEST

Data General's CONTEST is a diagnostic tool that runs under the operating system. If you are dealing with a PANIC situation, the drawback is that you have to bring up your operating system.

Another drawback to CONTEST is that it will only run your system primary tape device. If you have an MTA, MTC or MTD driver enabled for your system, you will not be able to run an MTJ device under CONTEST. Even if you have an MTJ as the primary tape device, you will not be able to run an MTJ secondary device. The only solution to this limitation would be to have a special version of the system, with only the driver of tape device you want to test enabled. This may be more bother than it is worth.

System Error Without PANIC Crash

When the system is able to read error status from a function it is performing, report it, and continue, you will have a better chance of determining what the problem is. For one thing, the device code of the device in an error state is reported.

Quite often the error can be the fault of another device. For example, if a high priority BMC device has a high burst rate configured with a low break count, other devices may have difficulty getting on the bus and will report errors. Changes may have to be made to both device configurations.

The error reported from the system may take a cryptic form. It may be a CB status or a PIO status taking the form of an octal number. Use Section 3.5.1 to help decipher these for your SKT-2300 Subsystem.

3.5.1 Interpreting CB and PIO Status

Status returned from the system usually takes the form of an octal number that needs to be deciphered.

The Difference Between CB Status & PIO

The MTJ driver borrows from Argus its use of two kinds of command structures:

CONTROL BLOCK (CB): Formal structures built in memory containing command and address information.

PROGRAMMED INPUT/OUTPUT (PIO): Single word registers containing different information depending on when you read or write them.

The address of the CB to be executed is passed from system to controller via a PIO register command.

Once either type of command is completed, the SKT-2300 Controller issues one of two types of interrupt to the system: synchronous after a CB completes, and asynchronous after a PIO command is done.

CB Status Meaning

Generally, if the completed command was a CB, you will get back: CB status, Error status or Unit status. These are written by the controller into a special part of the CB reserved for status, and are read by the system.

Table 3.5.1a Meaning of CB Status Word

The CB status word is reported in word 11 of the CB status block:

BIT	0	CB hard execution error
	1	CB Interpretation error
	2	Soft error executing CB
	3	Not used
	4	ECC correction used to recover
	5	ECC correction tried but failed
	6	Actual record count does not match request
	7-14	Not used
	15	CB done

Table 3.5.1b
Meaning of
Error & Unit
Status Words
from a CB

The CB Error word is reported in word 14 of the CB status block:

BIT	0	Controller interrupt timeout
	1	Controller/unit interface fault
	2	Controller timeout
	3	Data late
	4	Not used
	5	Unit error
	6	BMC timeout
	7	BMC ending memory address error
	8	Bad spot on tape
	9	Write protection fault
	10	Density mismatch
	11	Read/verify error
	12	BMC address/data transfer parity
	13	Controller to unit transfer parity
	14	Unit to media transfer parity
	15	Bad tape preamble

Table 3.5.1c
Meaning of
CB Unit
Status

The Unit Status word is reported in word 15 of the CB status block:

BIT	0	Unit command failed
	1	Unit power fail
	2	Unit READY
	3	Not used
	4	Reserved by other port
	5	Reserved by this port
	6	Hard unit failure
	7,8,9	Not used
	10	Indecipherable dump format
	11	BOT
	12	EOF
	13	Logical EOT
	14	Physical EOT
	15	Not used

PIO Status Meaning

The PIO registers also get status written into them. When a CB completes, the PIO register C is used. When a PIO command, (which mostly has to do with getting a CB issued) completes in error, PIO register B is used.

**Table 3.5.1d
Meaning of
PIO
Register C**

Bits 6 through 15 of REGISTER C after an asynchronous interrupt:

ASYNC OCTAL CODE	INTERRUPT NAME
0	Null interrupt
1	Controller panic
2	Soft error
3	Hard error (restart required)
4	Ibit set
5	Completed without error
6	Cancel list
7	Sbit set (restart required)
10	Interpretation error; CB status word not 0
11	Interpretation error; Illegal command
12	Interpretation error; Range error
13	Interpretation error; Illegal unit
14	Interpretation error; Illegal Link address
15	Interpretation error; Illegal Page address
16	Interpretation error; Illegal Transfer address
17	Interpretation error; Illegal Trans byte count
20	Unreadable CB
21	Unwritable CB
22	Map slot load request
23	Unit status change
24	Position status (EOF, EOT, LEOT, PEOT) no restart
25	Interpretation error; Illegal transfer count

Table 3.5.1e
Meaning of
PIO
Register B

A PIO Get, Set or Program Load command error may set a bit in REGISTER B:

BIT	0-6	Not used
	7	Ending memory address error
	8-11	Not used
	12	BMC error
	13-15	Not used

3.6 Help is Available for Problem Situations

In addition to an 800 number to call for assistance, there is a 48 hour turnaround policy on controller repairs. Exchange service is available from Authorized Zetaco Distributors on all subsystem components.

Whom to Call First

Zetaco Authorized Distributors provide support for their customers. Your distributor is your first level of support.

You Can Use the Customer Support Hotline

Zetaco provides a Customer Support Hotline to answer technical questions and to assist with installation and help troubleshoot problems. The Hotline technical team is available from 8:00 A.M. to 5:00 P.M. (CST), Monday through Friday.

Within the U.S. dial 1-800-537-5292

Outside the U.S. dial 1-612-941-5825

How to Get a Return Material Authorization (RMA)

A Return Material Authorization number is required before shipping anything to Zetaco. It should be referenced on the package and in any correspondence about the return. To get an RMA number:

1. Fill out a copy of the Material Return Information form shown on the next page and be prepared to give some of this information on the phone if asked. A copy of the filled out form should also be sent with any return package.
2. Call the Customer Support Hotline to request an RMA number from them.

Each product being returned needs a separate RMA number and Material Return Information form. It should be shipped to Zetaco, Inc., Eden Prairie, MN, freight prepaid.

Upon Zetaco's verification of defect, defective parts shall be repaired or replaced, and returned surface freight prepaid to the customer. In most cases, Tape drive units will be returned within thirty working days, and the Controller within two working days.

To safeguard the product during shipment, please use packaging that is adequate to protect it from damage. It would be a good idea to keep the original packaging for this purpose. Mark the box: *Delicate Instrument*. Indicate the RMA number(s) on the shipping label.

Information About Warranty

The SKT tape drives are warranted free from manufacturing and material defects, when used in a normal and proper manner, for a period of six months from date of shipment.

The SKT Controller is warranted free from manufacturing and material defects, when used in a normal and proper manner, for a period of two years from date of shipment.

Except for the express warranties stated above, Zetaco disclaims all warranties including all implied warranties of merchantability and fitness. The stated express warranties are in lieu of all obligations of liabilities on the part of Zetaco for damages, including but not limited to, special, indirect or consequential arising out of or in connection with the use or performance of Zetaco's products.

If a part is no longer under warranty, or if the problem is not warranted (as set forth above), then repair will be billable to the customer.



Material Return Information

The speed and accuracy of a product's repair is often dependent upon a complete understanding of the user's check-out test results, problem characteristics, and the user system configuration. Use the form below to record the results of your trouble-shooting procedures. If more space is needed, use additional paper.

TEST

RESULT

Power-up self-test

Other tests performed (system operation, errors, etc.):

Please allow our service department to do the best job possible by answering the following questions thoroughly and returning this information with the malfunctioning board.

1. *Does the problem appear to be intermittent or heat sensitive? (If yes, explain.)*
2. *Under which operating system are you running? (AOS, AOS/VS) Include revision number.*
3. *Describe the system configuration (i.e., peripherals, controllers, model of computer, etc.):*
4. *Has the unit been returned before?
Same problem?*

To be filled out by CUSTOMER:

MODEL NUMBER: _____

SERIAL NUMBER: _____

RMA NUMBER: _____ (Call Zetaco to obtain an RMA number.)

Returned by:

Your Name: _____ Firm: _____

Address: _____ Phone: _____

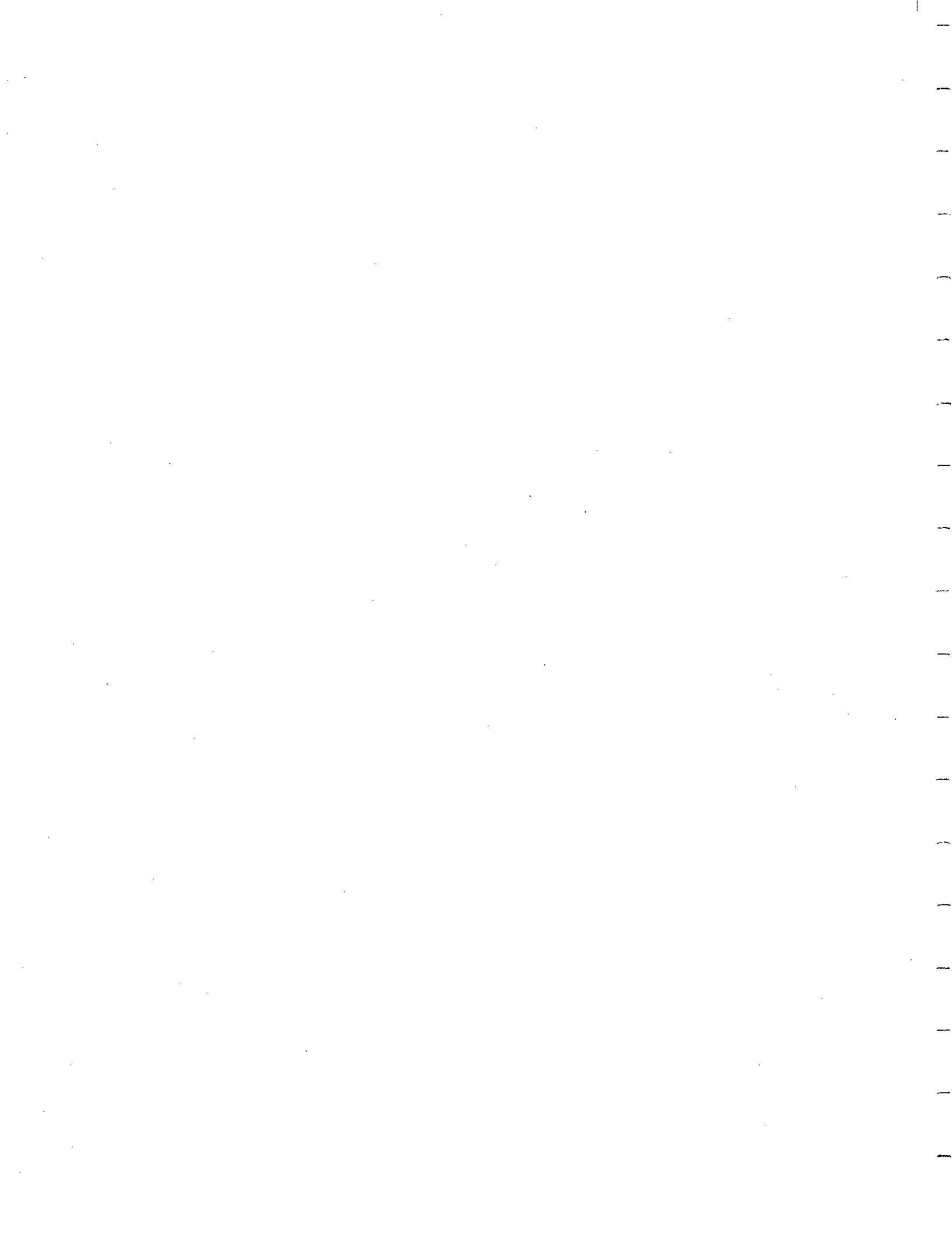

4.0 Using the SKT-2300 Efficiently

Its high capacity, small cartridge tape, and compatibility with an effective Data General driver make the SKT-2300 an attractive package. Use it in a manner that accentuates these features.

For each of the following features there is an associated caveat:

- HIGH CAPACITY It takes a LONG time to get to EOT.
- MTJ DRIVER This driver is not available with all revisions of AOS/VS or DG/UX.
- CARTRIDGE TAPE Your archive is only as good as the quality of the tape you buy and how you store it.

As with any subsystem, knowing how to USE the features of the SKT-2300 is an important part of the feature.

4.1 Setting up a Back-up Program

The beauty of a high capacity tape is that you don't have to stick around to put another reel of blank tape on the drive during back-up.

The SKT-2300 is best used as a back-up, archival device. It would take a long time to retrieve a file for a user application on line. The tapes are long and making a user wait is not cost effective.

It is cost effective to use the cartridge tape for back-up. In this manner of usage, the length of the tape is its advantage. A large amount of data can be stored on one tape, (which may eliminate the need for several reels) and the cartridges are small. This saves on storage and personnel costs.

A Word About Block Size

The tape drive writes data to tape in 1 KB blocks. This is done to facilitate its Helical Scan Technology. If a DUMP command is initiated using a block size that is less than 1 K or not a multiple of 1 K, the drive leaves the extra space blank. This could amount to a waste of tape.

Writing a Back-up Macro

With AOS/VS, it is possible to QBATCH or QSUBMIT commands for a specific day and time. The QBATCH or QSUBMIT could become part of a daily start up program. This allows you to stack up a back-up command that will not be performed until late at night. The following is an example:

```
QSUBMIT/AFTER=[!DATE]:20:00:00/QOUTPUT=@NULL BACK_UP_FILE
```

(QBATCH can be substituted for QSUBMIT.)

This command string will wait until 8:00 P.M. to execute the commands in the file BACK_UP_FILE. Another method would be to use:

```
QBATCH/AFTER=+12/QOUTPUT=@NULL BACK_UP_FILE
```

The commands in the file BACK_UP_FILE would execute after 12 hours had passed.

The file BACK_UP_FILE would be set up to contain the actual commands to the MTJ tape drive. It would look something like what is shown in Example 4.1a. Basically, the file sets up commands for a given directory, writes the start time and the directory name to the file USER.BACKUP.LIST and does the work. When it is done it issues a rewind.

With DG/UX, something similar could be done. UNIX has a process called *cron* that takes care of timed events. To time a back-up process as a night event, make an entry into the /usr/bin/crontab file:

```
0 20 * * 1-5 /usr/etc/backup
```

This entry will execute the backup file at 8:00 P.M. Monday through Friday.

The file, /usr/etc/backup, contains the commands to be executed. See example 4.1b.

Example 4.1a Partial AOS/VS BACK_UP_FILE

```
REWIND @MTJ0  
WRITE/L=USER.BACKUP.LIST FIRST DUMP STARTED AT [!TIME] ON [!DATE]  
DIR :  
WRITE/L=USER.BACKUP.LIST DUMPING UDD TO MTJ0 FILE 0  
DUMP/BUFF=16384/L=USER.BACKUP.LIST @MTJ0:0 UDD:#+.LS\+.PS\+.TMP  
WRITE/L=USER.BACKUP.LIST DUMPING MACROS TO MTJ0 FILE 1  
DUMP/BUFF=16384/L=USER.BACKUP.LIST @MTJ0:1 MACROS:#
```

and so on...

Example 4.1b Partial DG/UX Backup File

```
cd /  
echo 'Backup of /'  
echo 'Backup of /bin'  
find bin -depth -cpio /dev/rmt/c23d0n  
echo 'Backup of /etc'  
find etc -depth -cpio /dev/rmt/c23d0n  
echo 'Backup of /lib'  
find lib -depth -cpio /dev/rmt/c23d0n
```

and so on...

4.2 **Commands MTJ Understands**

The SKT-2300 will function with any MV computer running AOS/VS or DG/UX that supports the MTJ driver. The MTJ driver responds to all standard tape commands.

Tape Commands in AOS/VS

The SKT-2300 writes all tapes in the same density. You can omit density switches from all tape commands.

There are five commands commonly issued to a tape drive in AOS/VS through the CLI. They are:

DUMP, LOAD, DUMP_II, LOAD_II, REW

REWIND has no options. It returns the tape to BOT.

DUMP and DUMP_II share the same command format. DUMP_II has some command switches that will not work with DUMP. DUMP_II has the capability to be faster than DUMP. It uses more system resources (like memory). The amount of time saved depends on the availability of those resources to the DUMP_II program.

The commands are issued slightly differently, too. Since DUMP_II is a system utility, (the file DUMP_II.PR is in :UTIL) you must type XEQ (or X) DUMP_II.

Examples of DUMP/DUMP_II commands:

```
DUMP/V/R/BUFF=16384 @MTJ0:0 UDD:USER:+  
XEQ DUMP_II/V/R/BUFF=16384 @MTJ0:0 UDD:USER:+
```

Either of the resulting tapes could be read using LOAD or LOAD_II. (Do not mix formats on the same tape.)

LOAD and LOAD_II use the same command format. Any switch that will work on one will work on the other. LOAD_II has the capability to be faster than LOAD, when it has system resources available.

Examples of LOAD/LOAD_II commands:

```
LOAD/V/R/BUFF=16384 @MTJ0:0  
LOAD_II/V/R/BUFF=16384 @MTJ0:0
```

Creating a Physical Copy of Your Disk in AOS/VS

When you use DUMP or DUMP_II, you specify on the command line which files to save by using a file template. This requires that the system spend time deciding what to write. A speedy alternative to this process is PCOPY. PCOPY copies every used block of a disk onto tape. It can be used as a stand alone program, booted outside of the operating system, or in stand-among mode. Either way, it is faster than a regular DUMP.

Tape Commands With DG/UX

DG/UX creates device nodes from information in the file /usr/src/uts/mv/system each time the system is booted. Device node information is stored in directories /dev/mt and /dev/rmt, for blocked or raw devices, respectively.

Standard (blocked) I/O attempts to treat the tape like any other file. Any number of bytes at a time may be read or written. Nodes for the devices can be found in /dev/mt.

Character (raw) I/O reads one record at a time. Use when dealing with foreign tapes or with long records to be read or written. Raw device nodes can be found in /dev/rmt.

Use the following information to select the correct tape driver for your MTJ device and its functions:

```
character device = /dev/rmt/c23dx[lmh][n]
block device = /dev/mt/c23dx[lmh][n]
```

Replace x with the unit number of the tape drive.

Use l,m,h to designate low, medium or high density but since the SKT-2300 writes in one density, this may be omitted.

Use n if you wish the tape to rewind on close.

With DG/UX, there are two types of tape format: cpio and tar. There are various ways to issue a tape command in these formats and a variety of switches to use:

```
cpio format write . . . ls [filename/template]|cpio -o>/dev/[r]mt/c23d0
                        find [template] -depth -cpio /dev/[r]mt/c23d0
tar format write . . . /usr/etc/tar cvf /dev/[r]mt/c23d0 [filename]
cpio format read . . . cpio -i</dev/[r]mt/c23d0n
tar format read . . . /usr/etc/tar xvf /dev/[r]mt/c23d0n [filename]
cpio format list tape contents . . cpio -it</dev/[r]mt/c23d0n
tar format list tape contents . . . /usr/etc/tar tvf /dev/[r]mt/c23d0n
```

4.3 *Caring for the Tapes & Tape Drive*

It pays in terms of lost time, data and money, to use quality 8mm cartridge tapes, store them properly, and clean the tape drive on a regular basis.

Which Tapes to Use

Although the 8mm tape format is common enough to find at a corner drug store, you cannot be sure of the quality of the tape you buy. Since your data integrity depends on this quality, Zetaco recommends that you exclusively use EXABYTE 8mm tapes.

These are available from Zetaco and EXABYTE in these sizes:

<u>Cartridge Size</u>	<u>Length (feet)</u>	<u>Maximum Capacity (MB)</u>
256	45	291
512	90	583
1024	180	1166
2048	360	2332

Advice on Storing Tapes

It is a good idea to examine the environment in which the tapes will be stored according to these guidelines:

- ... Store the tapes vertically in their own case.
- ... Temperature should not exceed 15°C to 25°C
- ... Relative Humidity between 40 to 60% non-condensing.
- ... Avoid storage in places with dust, direct sunlight, or moisture.
- ... Keep tapes away from sources of magnetism.

Advice on Handling & Using Tapes

Follow these guidelines while you are using the tapes:

- ... Allow tape to acclimate to its environment for 24 hours or however long it has been exposed to other conditions, whichever is less.
- ... Operating temperature should be maintained between 5°C to 40°C.
- ... Relative Humidity between 20 to 80% non-condensing.
- ... Remove old labels instead of covering.
- ... Do not open cartridge lid or touch the tape.
- ... Do not try to open the cartridge or splice the tape.

Advice on Cleaning the Tape Drive

As a preventative measure, it is recommended that you clean your tape drive at regular intervals determined by use. In an environment that adheres to the stated guidelines, this would be once a month or after about 30 gigabytes of data transfer. (To help plan this, about 1 gigabyte of data is transferred during every hour of continuous streaming operation.)

ONLY the Cleaning Kit supplied by Zetaco or Exabyte can be used to clean the drive. Use of any other method such as: dry cleaning tapes, cloth or cotton swabs, and wet cleaning agents other than FREON TF reagent grade, are not acceptable substitutes and will **VOID YOUR WARRANTY**.

After spraying the cleaning tape with the wetting agent, insert it into the drive. The drive will recognize it as a cleaning tape; the cleaning material will be loaded into the tape path and moved forward for about 15 seconds. Then the tape will be drawn back into the cartridge and the cartridge ejected. The drive will be ready for use. Complete instructions are supplied with the Cleaning Kit.

The cleaning tape is designed to be used three times and then discarded. You should never attempt to rewind and reuse the cleaning tape. This would reintroduce dirt into the tape path.

If read/write problems are occurring, it is recommended that you use two cleaning passes in a row.

For more information on how to order the Cleaning Kit, call the Zetaco Sales department.

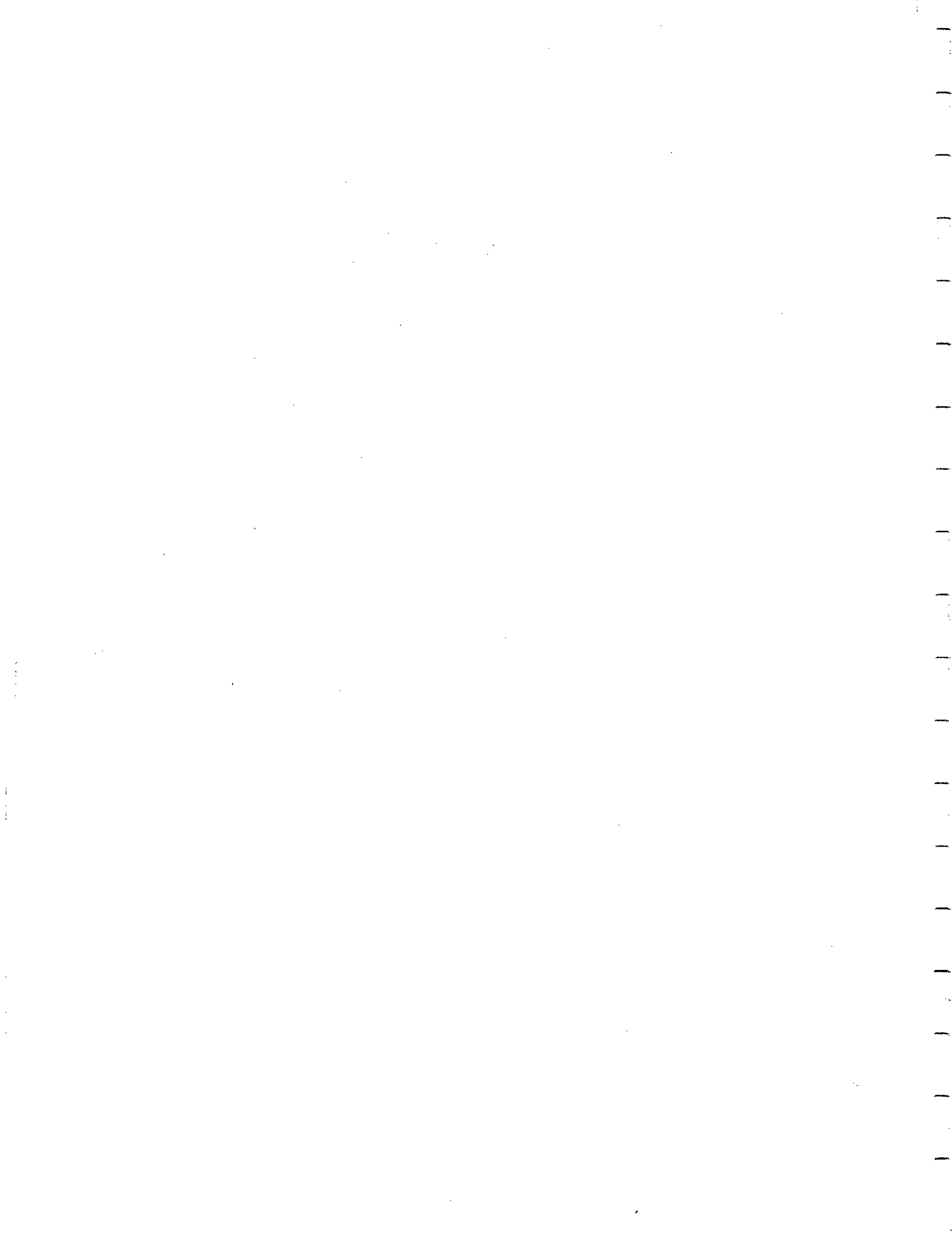



NO POSTAGE
NECESSARY
IF MAILED
IN THE
UNITED STATES

BUSINESS REPLY MAIL

FIRST CLASS

PERMIT NO. 939

HOPKINS, MN 55343

POSTAGE WILL BE PAID BY ADDRESSEE



6850 Shady Oak Road
Eden Prairie, MN 55344

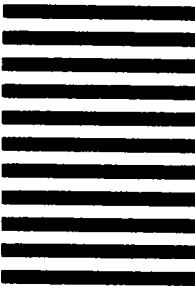



Please give us your comments.

Please use this form to send us your comments regarding this Technical Manual. Your input is greatly appreciated! Problems will be promptly addressed and action taken as necessary. If you wish a written reply, please furnish your name and mailing address. Thank you.

Date _____

Name _____ Title _____

Firm _____

Address _____

City/State/ZIP _____

TECHNICAL MANUAL TITLE _____

DOCUMENT NUMBER _____ REVISION _____

ERRORS IN MANUAL:

SUGGESTIONS FOR IMPROVING EITHER THE MANUAL OR THE PRODUCT:



6850 Shady Oak Road
Eden Prairie, Minnesota 55344 U.S.A.
(612) 941-9480/TELEX 290975